

actron ®

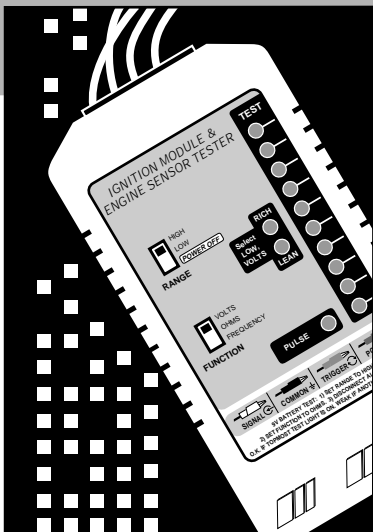

CP9087

SENSOR TESTER ™

PROFESSIONAL

Vehicle Service Info

The following publishers have manuals containing diagnostic information for electronic engine control and ignition systems. Contact the publishers for availability and pricing, specifying the make, model and year of your vehicle. Some manuals may be available at auto parts stores or your local public library.

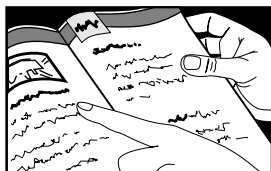

Vehicle Service Manuals

Chilton Book Company

Chilton Way
Radnor, PA 19089

Cordura Publications

Mitchell Manuals, Inc.
Post Office Box 26260
San Diego, CA 92126

Haynes Publications

861 Lawrence Drive
Newbury Park, CA 91320

Motor's Auto Repair Manual

Hearst Company
250 W. 55th Street
New York, NY 10019

Suitable manuals have titles such as:

"Electronic Engine Controls"

"Fuel Injection and Feedback Carburetors"

"Fuel Injection and Electronic Engine Controls"

"Emissions Control Manual"

... or similar titles.

Vehicle Service Manuals from General Motors Corporation

**Buick, Cadillac,
Chevrolet, GEO, GMC,
Oldsmobile & Pontiac**
Helm Incorporated
Post Office Box 07130
Detroit, MI 48207

Saturn

Adistra Corporation
c/o Saturn Publications
101 Union Street
Post Office Box 1000
Plymouth, MI 48170

Vehicle Service Manuals from Ford Motor Company (Ford, Lincoln, Mercury)

Ford Publication Dept.
Helm Incorporated
Post Office Box 07150
Detroit, MI 48207

Vehicle Service Manuals from Chrysler Corporation

Chrysler Corporation
Dymet Distribution Service
Post Office Box 360450
Strongsville, OH 44136

Vehicle Service Manuals from Toyota, Honda, Nissan

Toyota Motor Corporation
Toyota Service Publications
750 W. Victoria Street
Compton, CA 90220-5538

Honda Motor Co., Ltd.
Helm Incorporated
Post Office Box 07280
Detroit, MI 48207

Nissan North America, Inc.
Dymet Distribution Service
c/o Nissan
20770 Westwood Drive
Strongsville, OH 44136

Index

Section	Vehicle Service Information	Inside front cover
	Safety Precautions	ii
1	Tester Basics	1-1
2	Testing Sensors	2-1
	• Troubleshooting Tips	2-1
	• Engine Coolant Temperature	2-2
	• Inlet Air Temperature	2-3
	• Throttle Position (TP)	2-6
	• EGR Valve Position (EVP)	2-14
	• Oxygen	2-18
	• Engine Knock	2-26
	• Manifold Absolute Pressure (MAP/BARO)	2-28
	• Mass Air Flow (MAF)	2-34
	• Vane Air Flow	2-40
	• Crankshaft/Camshaft Position	2-46
	Magnetic Reluctance Type	2-49
	Hall Effect or Optical Type	2-51
3	Testing Ignition Modules	3-1
4	More Uses for the Sensor Probe	4-1
	• "Circuit Tester" Voltage Check	4-1
	• Continuity Checks	4-2
	• Diode Check	4-4

Safety First

General Safety Guidelines to Follow When Working on Vehicles

- Always wear approved eye protection
- Always operate the vehicle in a well-ventilated area. Do not inhale exhaust gases – they are very poisonous!
- Always keep yourself, tools, and test equipment away from all moving or hot engine parts.
- Always make sure the vehicle is in **Park** (automatic transmission) or **Neutral** (manual transmission) and that the parking brake is firmly set. Block the drive wheels.
- Never lay tools on vehicle battery. You may short the terminals together, causing harm to yourself, the tools, or the battery.
- Never smoke or have open flames near vehicle. Vapors from fuel or charging batteries are highly flammable and explosive.
- Never leave vehicle unattended while running tests.
- Always keep a fire extinguisher suitable for all types of fires handy.
- Always turn ignition key OFF when connecting or disconnecting electrical components, unless otherwise instructed.
- Use shop rags to cover fuel line fittings when connecting or disconnecting fuel lines. Avoid contact with fuel. Dispose of all rags properly.
- Clean up all fuel spills immediately.
- Keep away from engine cooling fan. On some vehicles, the fan may start up unexpectedly.
- You must follow vehicle service manual cautions when working around the air bag system. If the cautions are not followed, the air bag may open unexpectedly, resulting in personal injury. Note that the air bag can still open up several minutes after the ignition key is turned OFF (or even if the battery is disconnected) because of a special energy reserve module.
- Always follow vehicle manufacturer's warnings, cautions, and service procedures.

- Description of Controls and Accessories
- Installing and Checking the 9 Volt Battery

Note: Detailed procedures for testing sensors and ignition modules are located in Section 2 (sensors) and Section 3 (ignition modules).

① RANGE Switch

Controls power to the Tester and selects measurement range sensitivity (as required by various sensor tests).

- **POWER OFF** - No power supplied to either the tester or RED test lead.
- **LOW** - Tester powered up for use. Voltage from 9 volt battery supplied to RED test lead. Selects range for measuring low levels of voltage, resistance or frequency.
- **HIGH** - Tester powered up for use. Voltage from 9 volt battery supplied to RED test lead. Selects range for measuring higher levels of voltage, resistance or frequency.

② FUNCTION Switch

Selects the type of signal being measured (for conducting sensor and ignition module tests). Different kinds of signals are used by various sensors.

- **VOLTS** - Measures voltages. This function is used to test most sensors.
- **OHMS** - Measures resistance. Also used for checking continuity and testing diodes (see section 4). Mostly used for testing temperature sensors.
- **FREQUENCY** - Measures frequency signals. (Peak signal voltage must be at least 3 volts to register.) Some MAP and MAF sensors send a frequency signal. This function is also used to test ignition modules.

③

TEST Lights

A single TEST light turns on to show the level of a measured signal (voltage, resistance or frequency). When signal values are low, the TEST light is off or near the bottom of the column. The TEST light moves higher up the column as the signal level increases.

Sensor tests involve working the sensor and watching the TEST light move up, down or flash. Note that the motion of the light is more important than its actual position.

④

PULSE Light

Used when testing ignition modules. The PULSE light will flash if the module is good.

Note that the PULSE light will also be on (or flash) whenever frequency signals are being measured - this is normal.

⑤

RICH/ LEAN Lights

These lights are active when the tester switches are set to LOW VOLTS only.

- **LEAN (green):** ON for voltages between 0.1 and 0.59 volts.
- **RICH (red):** ON for voltages above 0.6 volts.

The RICH/LEAN lights work along with the TEST lights and are helpful when testing oxygen sensors. The RICH/LEAN lights may be ignored when testing other sensors using the LOW VOLTS range.

⑥

Test Leads

Two or more of these are used for the various tests and checks.

Yellow - The SIGNAL lead. Signals probed by this lead cause the TEST lights to react. Usually connected to a sensor or ignition module output circuit during testing.

Black - The COMMON lead. Used as a circuit ground or signal reference point for all tests and checks. This lead is always used.

Green - The TRIGGER lead. Used when testing ignition modules. Sends a signal to “fire” the module. Usually connected to the module crankshaft/camshaft input circuit.

Red - The 9V power lead. This lead is connected to the 9 volt battery inside the tester whenever the RANGE switch is in the LOW or HIGH positions. Ignition modules and some sensors require this power for testing.

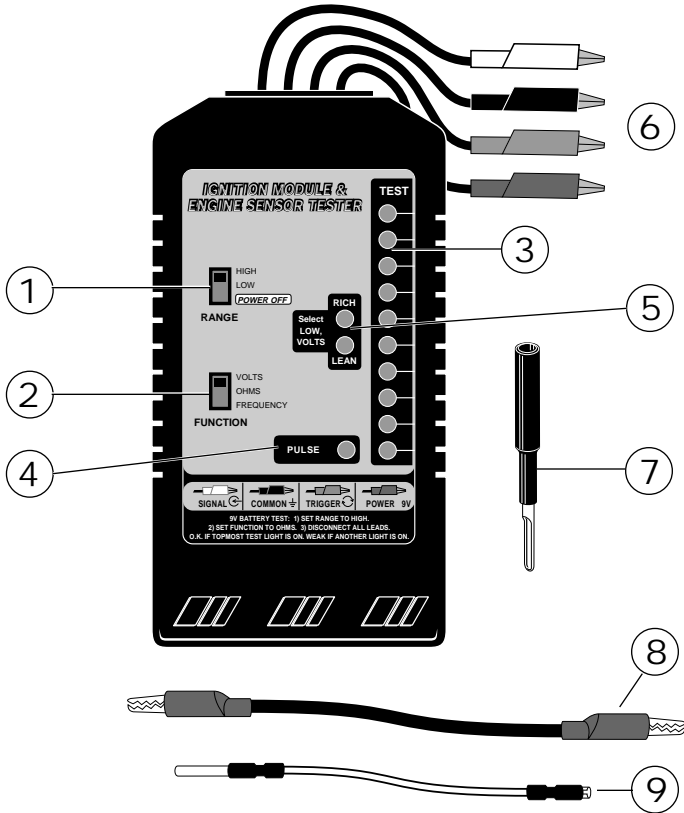

7 Backprobe Adapter

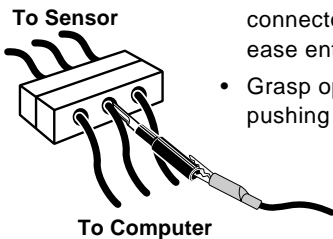

Allows test lead to probe sensor circuits when the sensor is connected to vehicle wiring harness.

- Slide the “scooped” end of adapter next to circuit wire entering rear of connector.
- Continue pushing adapter until it touches terminal inside connector. (Slightly twisting adapter while pushing may ease entry)
- Grasp open end of adapter with test lead clip. Keep pushing on adapter to maintain circuit contact.

Caution: The “scooped” end of the adapter will break if you bend it.

⑧ Jumper Lead

Used when checking some ignition modules. Makes extra connections as required for testing.

⑨ Connector Pin Adapters

Used for easier attachment of test leads to certain sensor or wiring connector pins.

- Push one end of the adapter onto the desired connector pin.
- Grasp the other end with the test lead clip.

Sensor Tester Power

A 9-volt transistor radio battery must be installed to power the unit. Use an alkaline battery (conventional batteries are too weak for ignition module testing).

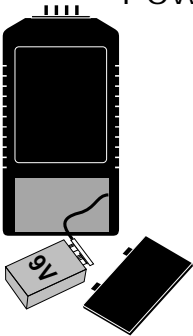

Installing the Battery

1. Hold the tester face down with both hands.
2. Using both thumbs, firmly press downwards and outwards on the battery compartment door at the bottom of the tester.
3. Slide the battery compartment door away from the tester to remove.
4. Attach battery to connector and install inside compartment.
5. Replace battery door. Slide door inwards until it snaps closed.

Checking the Battery

1. Make sure none of the test leads are connected together or touching anything.
2. Set RANGE switch to HIGH.
3. Set FUNCTION switch to OHMS.
4. Battery is good if the top TEST light is ON. If any light below the top TEST light is ON, the battery is too weak for reliable testing and should be replaced.

TIP: To extend battery life, always switch to POWER OFF when not making a measurement. This is safe to do even if the tester is connected to a circuit.

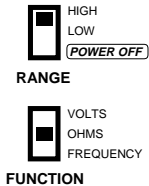

Testing Sensors

Troubleshooting Tips

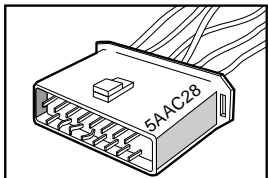
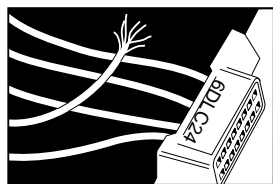
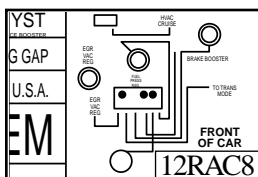

Save yourself time! Always begin with a thorough visual and “hands-on” inspection. You can often find the cause of many problems by just looking.

- Has the vehicle been serviced recently? Sometimes things get reconnected in the wrong place, or not at all.
- Don't take shortcuts. Inspect hoses and wiring which may be difficult to see due to location.
- Inspect the air cleaner and ductwork for defects.
- Check sensors and actuators for damage.
- Inspect all vacuum hoses for:
 - Correct routing. Refer to vehicle service manual, or Vehicle Emission Control Information (VECI) decal located in the engine compartment.
 - Pinches and kinks.
 - Splits, cuts or breaks.
- Inspect wiring for:
 - Contact with sharp edges (this happens often).
 - Contact with hot surfaces, such as exhaust manifolds.
 - Pinched, burned or chafed insulation.
 - Proper routing and connections.
- Check electrical connectors for:
 - Corrosion on pins.
 - Bent or damaged pins.
 - Contacts not properly seated in housing.
 - Bad wire crimps to terminals.

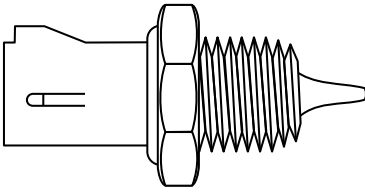

**Typical Engine Coolant
Temperature Sensor**

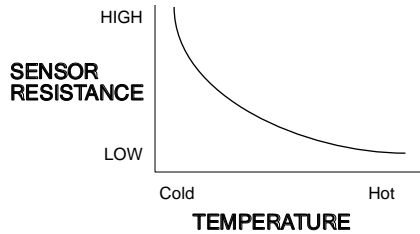

What is It?

The engine temperature sensor is a thermistor - a resistor whose resistance changes with temperature. The hotter the sensor gets, the lower the resistance becomes. The thermistor is mounted inside the tip of a threaded metal housing. This is a 2-wire sensor. (Exception: some Chrysler engines have a dual sensor with three wires.)

How is It Used?

The computer needs to know engine temperature so it can modify air/fuel ratios, spark advance, idle speed, and emission device operation (such as an EGR valve).

Location

The sensor is usually threaded into the engine block, lower intake manifold, or cylinder head to provide direct contact with coolant.

When to Test

- Related trouble codes sent by computer.
- Driveability problems such as hard starting, rough idle, stalling, hesitation, stumble, surging, knocking (pinging), poor fuel economy, or black exhaust smoke.

What to Inspect

Sensor operation (see test on page 2-4). Poor connections at sensor or computer. Faulty sensor wiring (open or short circuits). Heavy deposits on sensor tip which can cause poor response. Leakage into sensor housing. Engine running too hot (problems with antifreeze, thermostat, water pump, fan, belts, low engine oil).

Air TEMPERATURE

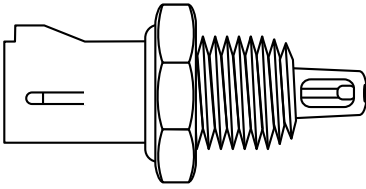

Typical Air Temperature Sensor

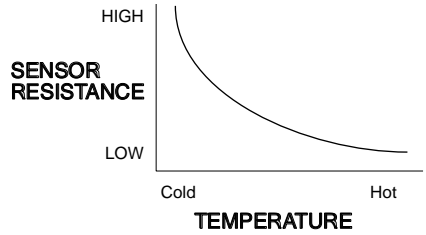

What is It?

The air temperature sensor is a thermistor - a resistor whose resistance changes with temperature. The hotter the sensor gets, the lower the resistance becomes. The thermistor is mounted inside the tip of a threaded metal housing. This is a 2-wire sensor.

How is It Used?

The computer needs to know air temperature to calculate the amount of air entering the engine. Then, the computer can provide the proper air/fuel mixture for the desired operating condition.

Location

The sensor is threaded into the intake manifold, throttle body, rear of air cleaner assembly or elsewhere along the path of air entering the engine. Sometimes this sensor is built into a vane airflow meter or mass airflow sensor assembly. One connector handles both the air flow and temperature sensor circuits.

When to Test

- Related trouble codes sent by computer.
- Driveability problems such as hard starting, rough idle, stalling, hesitation, stumble, surging, poor fuel economy, or black exhaust smoke.

What to Inspect

Sensor operation (see test on page 2-4). Poor connections at sensor or computer. Faulty sensor wiring (open or short circuits). Heavy deposits on sensor tip which can cause poor response. Restricted or blocked air passageways. Engine running too hot (problems with antifreeze, thermostat, water pump, fan, belts, low engine oil).

Temperature Sensor Test Procedure

Use this procedure for testing all engine coolant or inlet air temperature sensors.

Exceptions:

- Certain Toyota, Nissan and Ford engines using vane airflow sensors have the air temperature sensor built into the vane airflow assembly. Refer to page 2-40 for testing.
- GM 1988 2.8L Mass Airflow Sensor (5 pin only) also has a built-in air temperature sensor. Use same test procedure as for vane airflow temperature sensor. Refer to page 2-34 for testing.

Sensor may be tested on or off vehicle.

Warning: *On-car testing involves running engine. Observe all safety precautions (see page ii). Work in well ventilated area.*

1) Verify ignition key is OFF.

Allow engine to cool to outside temperature before testing.

2) Check Tester battery

Refer to page 1-4. Set RANGE switch to POWER OFF when done.

3) Disconnect wiring harness from sensor - Inspect for damage.

Some vehicles use a metal snap ring to secure wiring harness to sensor. Remove this snap ring before disconnecting wiring harness.

4) Off-Car testing only: Remove sensor.

Be careful of coolant spillage from mounting hole if removing engine temperature sensor.

5) Connect test leads.

- YELLOW to either sensor pin.
- BLACK to remaining sensor pin.

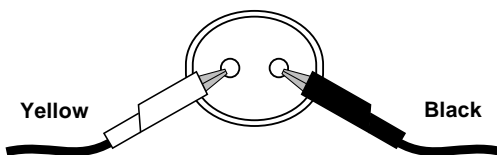

Engine Air TEMPERATURE

- 6) **Verify test clips make good contact and do not touch each other.**

Make sure red and green test clips are not touching anything.

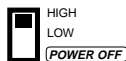

RANGE



FUNCTION

- 7) **Set RANGE switch to HIGH.**

- 8) **Set FUNCTION switch to OHMS.**

- 9) **Note TEST light position on tester.**

If the sensor is good, the light will move downwards as the sensor heats up.

- 10) **On-Car test only: Disconnect test leads and reconnect sensor to vehicle wiring harness.**

- 11) **Heat sensor tip thoroughly.**

On-Car test: Start engine and idle at 2000 RPM until upper radiator hose is hot.

Off-Car test:

- Dip sensor tip into boiling water, OR...
- (metal sensor housing) Heat tip with flame from candle or cigarette lighter OR...
- (plastic sensor housing) Heat tip with hair dryer.

- 12) **On-Car test only: Turn ignition key OFF. Disconnect vehicle wiring harness from sensor and reconnect test leads as before.**

- 13) **Observe TEST light position for test results.**

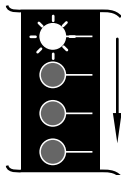

- **Good Sensor** - TEST light moved downwards below original position. (TEST light may go off if sensor is very hot - this is OK.) The TEST light will move upwards as the sensor cools off. Range of TEST light movement varies with sensor type and temperature change.

- **Bad Sensor** - TEST light position did not change during test.

- 14) **Testing is complete.**

Set RANGE switch to POWER OFF and remove all test leads.

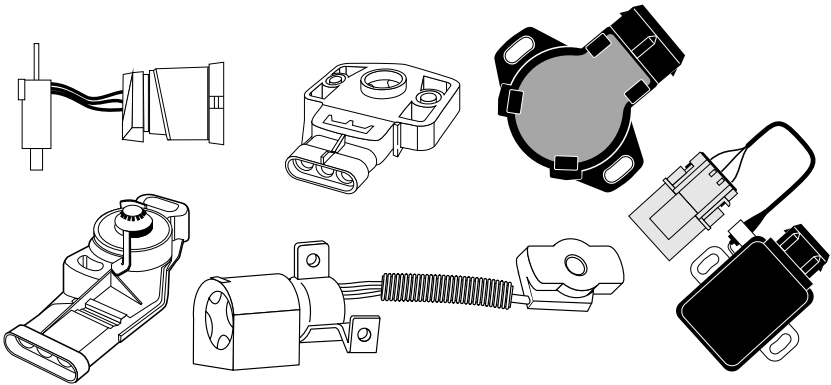

TYPICAL THROTTLE POSITION SENSORS

What
is It?

Throttle Position Sensor

The throttle position sensor is a potentiometer - a type of variable resistor (similar to a dashboard dimmer control). These sensors come in a wide variety of styles - some with connectors at the end of a short wire "pigtail". The computer supplies power and ground to the sensor. The sensor has an element which is turned (rotary type) or pushed (linear type). When the sensor is mounted on the engine, the element is linked to the throttle so they move together. The sensor sends a voltage signal back to the computer indicating element (and thus throttle) position. The voltage signal increases when the throttle opens and operates the sensor element. Throttle position sensors on Asian vehicles may also include one or two throttle position switches.

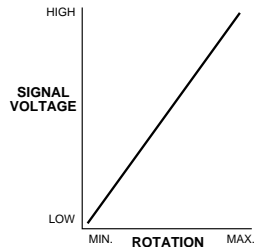

Throttle Position Switch

This is one or two switches usually built into a single housing (often resembling a throttle position sensor). Movement of the throttle linkage operates the throttle switches. The switches are wired to the computer. The computer usually supplies an ground connection to one side of each switch.

- The idle position switch is closed (or open - depends upon vehicle) when the throttle is resting. The switch operates when the throttle is opened (by any amount) and no longer in the idle position.

THROTTLE POSITION Sensor/Switch

- Sometimes a second switch is used to signal a wide open throttle condition. This switch is normally open (or closed - depends upon vehicle) when the throttle is at idle or just partially open. The switch operates when the throttle is opened beyond a certain point. (The amount of throttle opening required to operate the switch varies with vehicle.)

How it is used?

The computer uses throttle position to determine engine operating condition: idle (closed throttle), cruise (part throttle), or hard acceleration (wide open throttle). The computer can then properly control air/fuel mixtures, spark advance, idle speed, and lock-up torque converters.

Location

Fuel injected engines: Rotary type sensor - usually mounted to outside of throttle body and linked to throttle shaft.

Computer controlled carburetor engines: Linear (sliding) type - usually mounted inside carburetor (GM) or outside carburetor (Ford).

When to Test

- Related trouble codes sent by computer.
- Driveability problems such as hard starting, rough idle, stalling, hesitation, stumble, surging, knocking (pinging), poor fuel economy, backfiring, no torque converter lock-up.

What to Inspect

Sensor operation (see test on page 2-10) or switch operation (see test on page 2-12). Poor connections at sensor or computer. Sensor position adjustment. Faulty sensor wiring (open or short circuits). Binding throttle shaft or linkage. If used: "Cruise Control" linkage problems, idle speed control motor, vacuum hose connected to throttle positioner, choke, or cam systems affecting throttle position.

Throttle Position Sensor Connectors

A = Test A, page 2-10

B = Test B, page 2-12

Some sensors require more than one test.

Note: If the Red and Black test lead hook-ups are reversed, the TEST light will move in the opposite direction during Test A. This does not affect the accuracy of the test or harm the sensor.

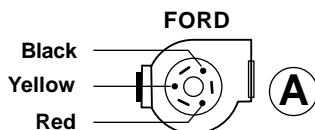
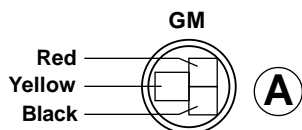

GM, FORD, CHRYSLER, HONDA

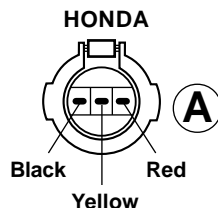
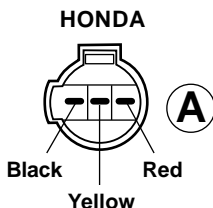
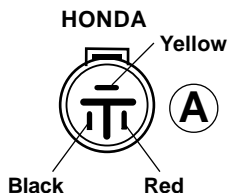
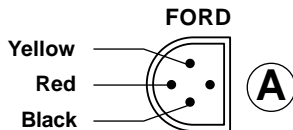
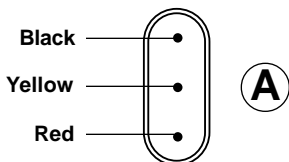

Refer to vehicle service manual for connectors not shown. Hook up as follows:

- **Red** test lead to sensor power pin
- **Yellow** test lead to sensor signal pin
- **Black** test lead to sensor ground pin

THROTTLE POSITION Sensor/Switch

TOYOTA

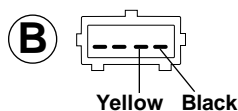
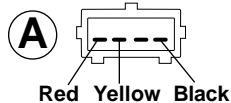
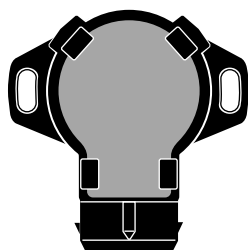

TOYOTA/NISSAN

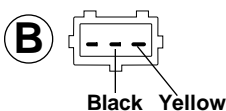
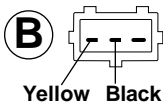
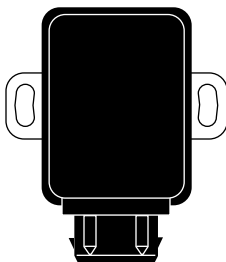

Not used on some vehicles. Perform this test only if vehicle mating connector has 3 wires.

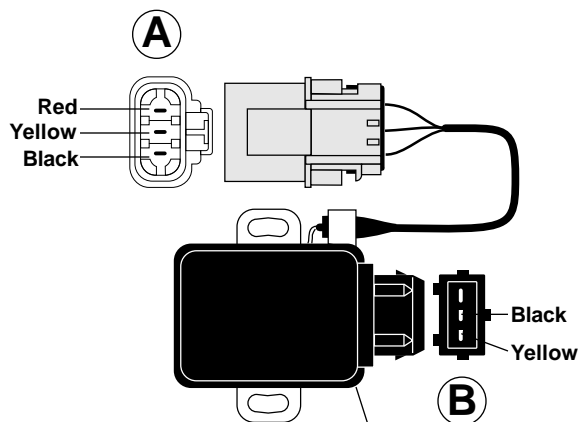

Some sensors have cable attached here. Testing is identical.

(B)

Yellow
Black

Not used on some vehicles. Perform this test only if vehicle mating connector has 3 wires.

TEST A - Throttle Position Sensor

Important: If more than one hook-up is shown, it means more than one test is required to check all parts of the sensor. Do all tests shown for your sensor. The letter next to the hook-up refers to the test procedure.

Sensor may be tested on or off vehicle. (Exception: On-car test only for most Honda - sensor permanently attached to throttle body.)

Warning: Observe all safety precautions (see page ii) if testing sensor on vehicle.

1) Verify ignition key is OFF.

2) Check Tester battery

Refer to page 1-4. Set RANGE switch to POWER OFF when done.

3) Disconnect wiring harness from sensor - Inspect for damage.

Some vehicles use a metal snap ring to secure wiring harness to sensor. Remove this snap ring before disconnecting wiring harness.

4) Off-Car testing only: Remove sensor.

IMPORTANT: Many throttle position sensors require special adjustment when reinstalled. Refer to vehicle service manual for adjustment procedure. A good sensor will not perform properly if incorrectly adjusted.

5) Connect test leads.

Connect TEST leads according to diagram **A** in the component drawing.

6) Verify test clips make good contact and do not touch each other.

Make sure unused clips are not touching anything.

7) Honda only: 1988-92 Civic and CRX

- Remove vacuum hose from dashpot diaphragm.
- Apply 20 in. Hg to the dashpot diaphragm using a hand vacuum pump.
- The dashpot diaphragm is part of the throttle body assembly. It is used to control cold engine fast idle and throttle closure speed so engine will not stall.

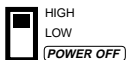

RANGE

8) Set RANGE switch to HIGH.



FUNCTION

9) Set FUNCTION switch to VOLTS.

10) Operate sensor - Watch TEST light for results.

(Note: TEST light may be on or off before sensor is operated.)

On-Car test: Slowly move throttle linkage back and forth from idle to wide open position.

Off-Car test: Slowly rotate sensor element back and forth from end to end.

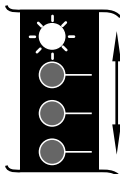

- **Good Sensor** - TEST light smoothly moves up or down as sensor is operated. (The TEST light may go off if it moves to the bottom of the column - this is O.K.) Range of TEST light movement varies with sensor type and vehicle mounting.
- **Bad Sensor** - TEST light position does not change during test OR light movement is erratic, showing a sudden jump or dip during smooth sensor operation.

11) Testing is complete.

Set RANGE switch to POWER OFF and remove all test leads.

TEST B - Throttle Position Switch

Important: If more than one hook-up is shown, it means more than one test is required to check all parts of the switch. Do all tests shown for your switch. The letter next to the hook-up refers to the test procedure.

Switch may be tested on or off vehicle.

Warning: Observe all safety precautions (see page ii) if testing sensor on vehicle.

1) Verify ignition key is OFF.

2) Check Tester battery

Refer to page 1-4. Set RANGE switch to POWER OFF when done.

3) Disconnect wiring harness from switch - Inspect for damage.

Some vehicles use a metal snap ring to secure wiring harness to switch. Remove this snap ring before disconnecting wiring harness.

4) Off-Car testing only: Remove switch.

IMPORTANT: Many throttle position switches require special adjustment when reinstalled. Refer to vehicle service manual for adjustment procedure. A good switch will not perform properly if incorrectly adjusted.

5) Connect test leads.

Connect TEST leads according to diagram **B** in the component drawing.

6) Verify test clips make good contact and do not touch each other.

Make sure unused clips are not touching anything.

THROTTLE POSITION Sensor/Switch



RANGE

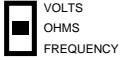

FUNCTION

7) Set RANGE switch to HIGH.

8) Set FUNCTION switch to OHMS.

9) Operate sensor - Watch TEST light for results.

On-Car test: Slowly move throttle linkage back and forth from idle to wide open position.

Off-Car test: Slowly rotate sensor element back and forth from end to end.

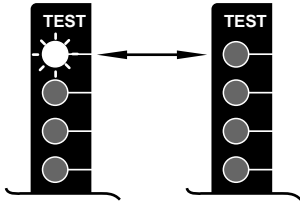

- **Good Switch** - TEST light switches between being ON at top of column and OFF
- **Bad Switch** - TEST light always ON at top of column or always OFF.

10) Testing is complete.

Set RANGE switch to POWER OFF and remove all test leads.

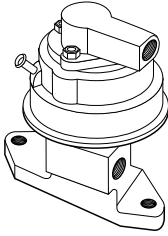

**FORD
EGR Valve**

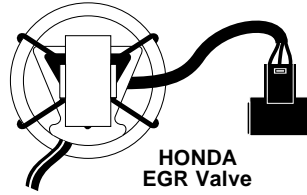

**HONDA
EGR Valve**

What is it?

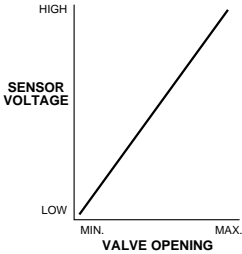

This sensor is a potentiometer - a type of variable resistor (similar to a dashboard light dimmer control). The computer supplies power and ground to the sensor. The sensor has a shaft which is pushed. When the sensor is mounted on the EGR valve, the shaft gets pushed as the valve opens. The sensor sends out a voltage signal indicating the amount of valve opening ("lift"). The voltage signal gets larger the more the valve is opened.

How it is used?

The computer is programmed to provide optimum EGR flow during idle, cruise, and hard acceleration operating conditions. The computer uses the sensor signal to calculate actual EGR flow. Then the computer can modify the EGR valve opening as required.

Location

Attached to the top of the EGR valve.

When to Test

- Related trouble codes sent by computer.
- Driveability problems such as hesitation, stumble, surging, poor fuel economy, erratic acceleration, knocking (pinging), no torque converter lock-up.

What to Inspect

Sensor operation (see page 2-15). Poor connections at the sensor or computer. Damaged or sticking EGR valve. Worn or broken vacuum hoses, vacuum connectors. Damaged vacuum reservoir, canister. Problems with control solenoids supplying operating vacuum to open EGR valve.

EGR Valve Position Sensor Test Procedure

Sensor may be tested on or off vehicle.

Warning: Observe all safety precautions (see page ii) if testing sensor on vehicle.

1) Verify ignition key is OFF.

2) Check Tester battery

Refer to page 1-4. Set RANGE switch to POWER OFF when done.

3) Disconnect wiring harness from sensor - Inspect for damage.

Some vehicles use a metal snap ring to secure wiring harness to sensor. Remove this snap ring before disconnecting wiring harness.

4) Off-Car testing only: Remove sensor.

Note: Some sensors are permanently attached to the EGR valve and cannot be removed.

5) Connect test leads according to diagram.

6) Verify test clips make good contact and do not touch each other.

Make sure unused clips are not touching anything.

7) Set RANGE switch to HIGH.

8) Set FUNCTION switch to VOLTS.

9) Operate sensor - Watch TEST light for results.

(Note: TEST light may be on or off before sensor is operated.)

On-Car test:

- Remove vacuum control hose from EGR valve.
- Connect hand vacuum pump to EGR valve.
- Gradually apply vacuum to slowly open valve.

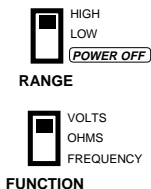

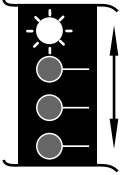

Off-Car test: Slowly push sensor element back and forth from end to end.

- **Good Sensor** - TEST light smoothly moves up or down as sensor is operated. (The TEST light may go off if it moves to the bottom of the column - this is O.K.) Range of TEST light movement varies with sensor type and vehicle mounting.

- **Bad Sensor** - TEST light position does not change during test OR light movement is erratic, showing a sudden jump or dip during smooth sensor operation.

10) Testing is complete.

Set RANGE switch to POWER OFF and remove all test leads.

Sensor Connectors

Note: If the Red and Black test lead hook-ups are reversed, the TEST light will move in the opposite direction during the test. This does not affect the accuracy of the test or harm the sensor.

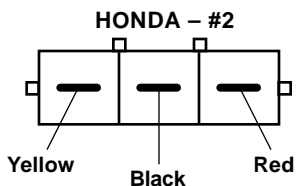
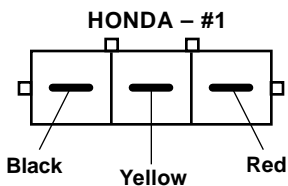
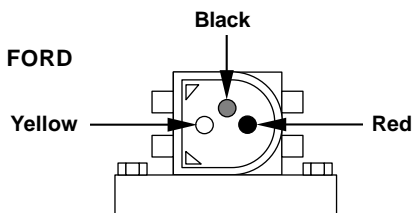

Honda uses two sensor types. Try hook-up #1 first. If good test results are not obtained, retest using hook-up #2 before judging sensor.

Refer to vehicle service manual for connectors not shown. Hook up as follows:

- **Red** test lead to sensor power pin
- **Yellow** test lead to sensor signal pin
- **Black** test lead to sensor ground pin



Typical Oxygen Sensor

What is It?

The oxygen sensor is a zirconium dioxide ceramic mounted in the tip of a threaded metal housing. The tip is perforated to protect the sensing element but still allow exhaust gases to pass through.

The sensor produces a voltage signal based on the amount of oxygen it contacts. A low voltage indicates a lean exhaust (too much oxygen). A higher voltage signals a rich exhaust (not enough oxygen).

The sensor must be very hot to operate: 349(C (660(F). Many have 2-wire heating elements built-in to quicken the warm-up time.

How it is used?

The computer uses this sensor to calculate optimum air/fuel mixture for low emissions and good fuel economy. If the sensor indicates a rich exhaust (not enough oxygen because of too much fuel), the computer will compensate by reducing fuel delivery. If the computer receives a lean signal (too much oxygen because of too little fuel), it will increase fuel delivery. NOTE: Some vehicles use more than one oxygen sensor.

Location

The sensor is threaded into the exhaust manifold to give it direct contact with the exhaust gases.

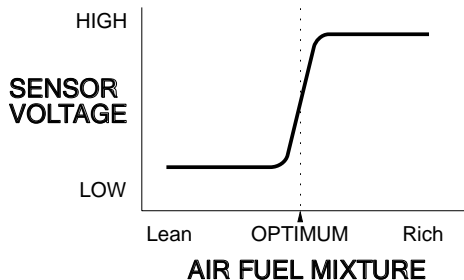

When to Test

- Related trouble codes sent by computer.
- Driveability problems such as rough running, hesitation, stumble, poor fuel economy, poor performance, black exhaust smoke.

Inspection

Sensor operation (see page 2-21). Poor connections at the sensor or computer.

This sensor often fails because of contamination from fuel, oil additives, gasket sealer or an overly rich running engine. Factors which can make a rich running engine include: ignition system problems (coil, distributor cap, rotor, spark plugs, wires), fuel contaminated by engine oil, emission devices (carbon canister, EGR valve, PCV valve, air injection system), manifold leaks, air filter, fuel pressure and engine not at normal operating temperature.

IMPORTANT: Some engines (usually off-road applications) use a titania-type oxygen sensor. This sensor resembles the common zirconium type, but has an open-ended tip. The titania sensor changes resistance when it operates. This tester is not designed to test the titania type sensor.

Sensor Types

1-Wire: Single wire goes to sensor SIGNAL. Sensor housing is connected to sensor GROUND.

2-Wire: One wire goes to sensor SIGNAL. Second wire goes to sensor GROUND. Refer to vehicle service manual for wire identification. (Sensor wire is often black.)

3-Wire: Two wires (often the same color) go to the sensor heating element. Third wire (different color from the others) goes to sensor SIGNAL. Sensor housing is connected to sensor GROUND.

4-Wire: Two wires (often the same color) go to the sensor heating element. Third wire goes to sensor SIGNAL. Fourth wire goes to sensor GROUND. Refer to vehicle service manual for wire identification. (Signal wire is often black.)

Heating Element Test

- Do this test if sensor has a heating element (3 or 4 wire connector).
- If sensor has 1 or 2 wire connector, do not do this test. Go directly to On-Car Test (page 2-22).

Warning: Observe all safety precautions (see page ii) if testing sensor on vehicle.

1) Verify ignition key is OFF.

2) Check Tester battery

Refer to page 1-4. Set RANGE switch to POWER OFF when done.

3) Disconnect wiring harness from sensor - Inspect for damage.

Some vehicles use a metal snap ring to secure wiring harness to sensor. Remove this snap ring before disconnecting wiring harness.

4) Connect test leads.

- YELLOW to either sensor HEATER pin.
- BLACK to remaining sensor HEATER pin.

5) Verify test clips make good contact and do not touch each other.

Make sure unused clips are not touching anything.

6) Set RANGE switch to HIGH.

7) Set FUNCTION switch to OHMS.

8) Observe TEST light for test results.

- **Good Heater:** TEST light OFF (low resistance).
- **Bad Heater:** TEST light ON in any position (resistance too high, or open circuit).

9) Heating Element test is complete.

- Set RANGE switch to POWER OFF and remove all test leads.
- Go to On-Car Test.

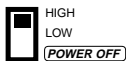

RANGE

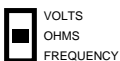

FUNCTION



On-Car Test

Important: *Reliable testing of the oxygen sensor while on-vehicle is very difficult because test conditions cannot be well controlled. If the sensor responds during on-car testing, then it is probably good and no other testing is necessary. If the sensor does not seem to respond when tested on-car, remove it and perform the off-car test before deciding whether or not the sensor is bad.*

Warning: *This test involves running the engine. Observe all safety precautions (see page ii). Work in well-ventilated area.*

1) Verify ignition key is OFF.**2) Check Tester battery**

Refer to page 1-4. Set RANGE switch to POWER OFF when done.

3) Connect test leads.

- YELLOW to sensor SIGNAL circuit.
- BLACK to good vehicle GROUND.
- Keep sensor connected to vehicle wiring and use backprobe adapter to contact sensor SIGNAL circuit if possible.
- If you cannot use backprobe, disconnect sensor connector and connect YELLOW test lead directly to sensor SIGNAL pin. Note: Most computer systems will store a trouble code in memory (and turn on the “Check Engine” light) if engine is run with sensor disconnected. Ignore or erase the code after testing. Refer to Vehicle Service Manual.

4) Verify test clips make good contact.

Make sure unused clips are not touching anything.

5) Set RANGE switch to LOW.**6) Set FUNCTION switch to VOLTS.****7) Start engine - Idle until hot.**

Run engine until upper radiator hose is hot and pressurized.

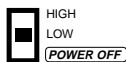

RANGE



FUNCTION

8) Observe RICH/LEAN lights during fast idle.

- The TEST light column also indicates sensor voltage, but it is easier to check operation by watching the RICH/LEAN lights.)

- Maintain throttle partially open (2000 RPM idle).

- IF the RICH/LEAN lights flash back and forth every 3 seconds or less...

THEN the sensor is good and no further testing is necessary. Go to step 10.

- IF it takes longer than 3 seconds for the RICH/LEAN lights to switch back and forth...

THEN the sensor may be degraded. Go to step 10, then do the Off-Car test on page 2-24

- IF the RICH/LEAN lights do not flash back and forth...

THEN go to step 9.

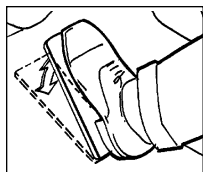

9) Observe RICH / LEAN lights during throttle changes.

- Quickly move throttle from idle to partially open (2000 RPM) position then back to idle. (This attempts to create a momentary rich or lean engine operating condition.) Repeat this throttle action several times while observing the RICH/LEAN lights.

- IF the RICH/LEAN lights switch within 3 seconds of the throttle action...

THEN the sensor is good and no further testing is necessary. Go to step 10.

- IF it takes longer than 3 seconds for the RICH/LEAN lights to switch...

THEN the sensor may be degraded. Go to step 10. Do the Off-Car test on page 2-24

- IF the RICH/LEAN lights do not flash back and forth...

THEN go to step 10. Do the Off-Car test on page 2-24.

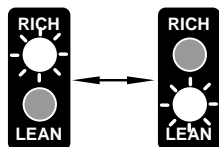

10) On-Car test is complete - Turn ignition key OFF.

- Set RANGE switch to POWER OFF and remove all test leads.

- If the RICH / LEAN lights did not flash, or flashed too slowly, in steps 8 or 9, then do the Off-Car test on page 2-24.

Off-Car Test

Warning: This test involves use of an open flame from a propane torch. Observe all safety precautions for torch operation. Do not use near flammable material or gases.

1) Verify ignition key is OFF.

2) Check Tester battery

Refer to page 1-4. Set RANGE switch to POWER OFF when done.

3) Disconnect wiring harness from sensor - Inspect for damage.

Some vehicles use a metal snap ring to secure wiring harness to sensor. Remove this snap ring before disconnecting wiring harness.

4) Remove sensor.

5) Firmly grasp sensor with a pair of locking pliers.

6) Connect test leads

- YELLOW to sensor SIGNAL pin.
- BLACK to sensor GROUND.

7) Verify test clips make good contact and do not touch each other.

Make sure unused clips are not touching anything.

8) Set RANGE switch to LOW.

9) Set FUNCTION switch to VOLTS.

10) Light torch - Heat sensor tip - Observe RICH/LEAN lights.

- Thoroughly heat sensor tip until tip is as hot as possible, but not “glowing”. See Fig. 1.
- The sensor tip must be very hot to operate! (349(C, 660(F)
- The LEAN or RICH light should be ON. If both lights are off, the sensor is defective.

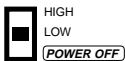

RANGE



FUNCTION

11) Observe RICH/LEAN lights while operating sensor.

- After sensor tip is hot, move the flame until the sensor tip is completely surrounded by the flame. This keeps oxygen away from the tip. See Fig. 2.
 - **Good Sensor:** RICH light turns ON within 3 seconds indicating a “rich” (low oxygen) condition.
 - **Bad Sensor:** RICH light takes longer than 3 seconds to turn on, or does not turn on at all.
- Move flame so oxygen can reach sensor tip. (Keep sensor tip hot with flame.) See Fig. 1.
 - **Good Sensor:** LEAN light turns ON within 3 seconds indicating a “lean” (high oxygen) condition.
 - **Bad Sensor:** LEAN light takes longer than 3 seconds to turn on, or does not turn on at all.

12) Repeat step 11 a few times to verify results.

13) Testing is complete.

Extinguish flame, set RANGE switch to POWER OFF, let sensor cool and remove test leads.

IMPORTANT: *Special anti-seize compound must be applied to sensor housing threads before reinstallation. Refer to vehicle service manual for proper type.*

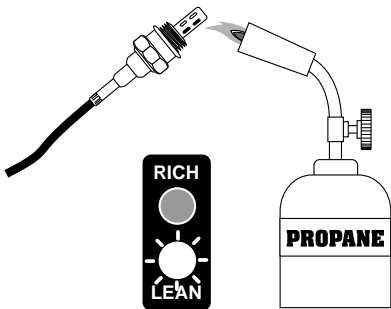

Fig. 1

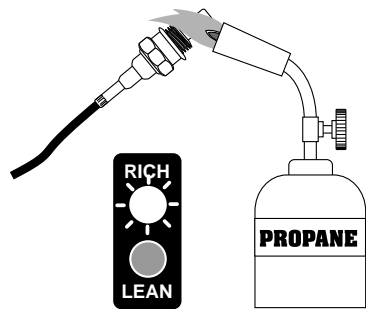
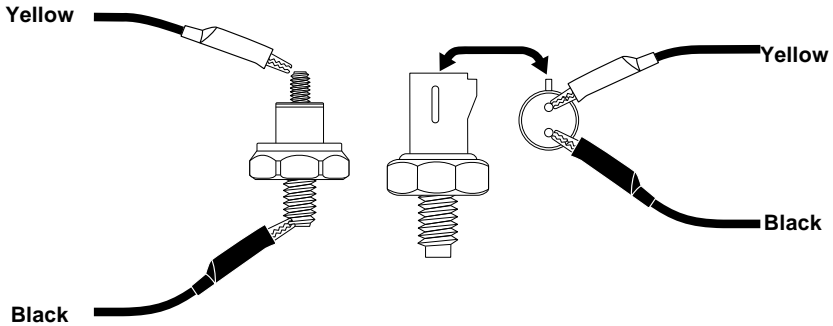

Fig. 2



What is It?

The knock sensor is a piece of piezoelectric material mounted in a metal housing. The sensor acts like a microphone - it changes vibrations into a small AC voltage signal. The sensor usually has a one wire or two wire connector.

How it is used?

The computer (or other spark timing controller) is designed to recognize sensor signals caused by engine knock vibrations. Then, spark timing is retarded to eliminate the damaging knock condition

Location

Usually threaded into (or bolted on) the engine block, intake manifold or exhaust manifold. Often near the cylinder heads.

When to Test

- Related trouble codes sent by computer.
- Knocking during cruise or hard acceleration (not enough spark retard), hesitation, poor performance and fuel economy (excess spark retard).

What to Inspect

Sensor operation (see test on page 2-27). Poor connections at sensor or computer. Faulty sensor wiring (open or short circuits). Spark timing. Bad fuel quality.

Knock Sensor Test Procedure

Sensor may be tested on or off vehicle.

Warning: Observe all safety precautions (see page ii) if testing sensor on vehicle.

- 1) Verify ignition key is OFF.
- 2) Check Tester battery (refer to page 1-4).
- 3) Disconnect wiring harness from sensor - Inspect for damage.
- 4) Connect test leads to sensor.

One-wire connector:

- YELLOW test lead to signal pin (top of sensor).
- BLACK test lead to body of sensor (off-car) or nearby ground (on-car).

Two-wire connector:

- YELLOW test lead to either sensor pin.
- BLACK test lead to remaining sensor pin.

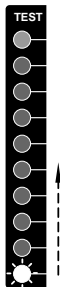
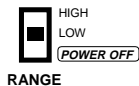

- 5) Set RANGE switch to LOW.
- 6) Set FUNCTION switch to VOLTS.
- 7) Operate sensor - Watch TEST light for results.

(Note: Ignore any RICH/LEAN light flashes.)

On-car test: Lightly tap surface near sensor using a socket extension (or similar tool) and a light hammer. Do not tap directly on sensor!

Off-car test: Grasp sensor firmly. Gently tap sensor tip with a light hammer.

– **Good sensor:** TEST lights flash upward from the bottom of the TEST light column during a tap. (Only a few lights may flash. This is O.K.) Range of TEST light movement varies with sensor type and tapping force.

– **Bad sensor:** TEST lights do not flash during a tap.

- 8) Testing is complete.

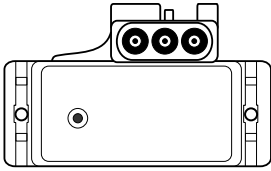

GM/CHRYSLER

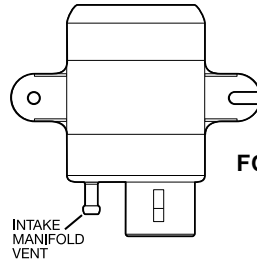

FORD

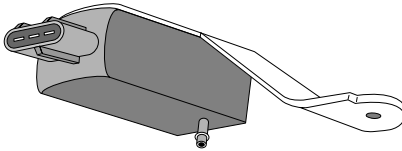
INTAKE
MANIFOLD
VENT

TOYOTA/HONDA

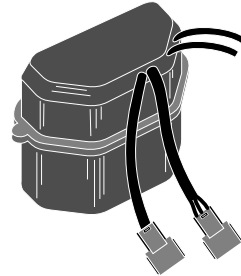

Manifold Absolute Pressure (MAP) Sensor Barometric Pressure (BARO) Sens

What is It?

This sensor is an electronic module which sends a signal to the computer indicating atmospheric pressure and/or engine vacuum. Depending upon sensor type, the signal may be a dc voltage or a frequency. More pressure (less vacuum) makes the sensor signal increase (higher voltage or frequency). The computer supplies power and ground to the sensor.

How it is used?

The computer needs to know air pressure both outside and inside the manifold to properly adjust the air/fuel mixture and ignition timing for varying engine load and altitude conditions. On turbo-charged engines, the computer also uses the sensor to monitor boost pressure and operate the wastegate accordingly.

Manifold Absolute Pressure MAP/BARO

Location

The sensor is mounted either on the bulkhead, air cleaner, throttle body or elsewhere in the engine compartment. A vacuum hose connects the sensor to a strong source of manifold vacuum. (Some new MAP sensor types may be directly mounted to the manifold, eliminating the vacuum hose connection.) The BARO sensors are vented to the atmosphere - there is no vacuum hose attached.

Some Honda engines locate the MAP sensor inside a control box containing several vacuum hoses and solenoids.

When to Test

- Related trouble codes sent by computer.
- No start, hard starting, stalling, rough idle, hesitation, stumble, surging, poor fuel economy, black exhaust smoke, knocking, backfiring, catalytic converter overheating or no torque converter lock-up.

Vehicle Harness Connectors for MAP Sensor

(Mating side of connector shown.)

GM/CHRYSLER

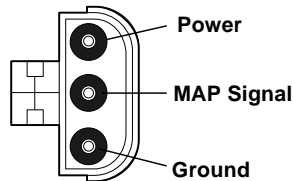

FORD

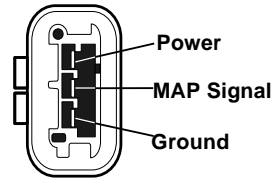

HONDA

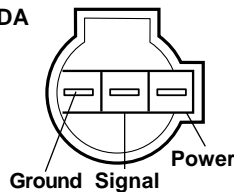
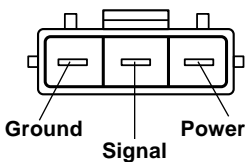

TOYOTA

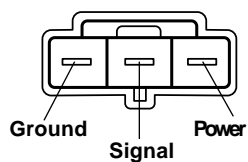

Refer to vehicle service manual for connectors not shown.

Manifold Absolute Pressure (MAP) Sensor Test Procedure

Testing is done on-vehicle.

Warning: This test involves running the engine. Observe all safety precautions (see page ii). Work in well-ventilated area.

1) Verify ignition key is OFF.

2) Check Tester battery

Refer to page 1-4. Set RANGE switch to POWER OFF when done.

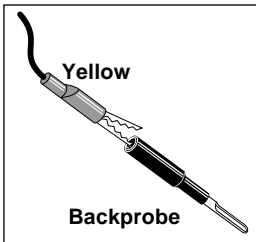

3) Connect test leads.

Keep sensor connected to vehicle wiring.

- YELLOW to sensor SIGNAL circuit. Use backprobe adapter.
- BLACK to good vehicle GROUND.

4) Verify test clips make good contact.

Make sure unused clips are not touching anything.

5) Set switches:

- RANGE on HIGH.
- FUNCTION on VOLTS.

Exception:

Ford vehicles with frequency type sensor (see diagram).

- RANGE on LOW.
- FUNCTION on FREQUENCY.

6) Turn ignition key ON but DO NOT START ENGINE.

7) Note TEST light position on tester.

- If the sensor is good, the light will move downwards when vacuum is applied.

- **Note:** If the TEST light is OFF a problem exists. Go to step 9 and continue testing to find cause.

8) Operate sensor - Watch TEST light for results.

(Note: Ignore any PULSE light action.)

Non-Turbo Engines only: Start engine and let idle.

Turbo Engines only: Attach hand vacuum pump to sensor vacuum port. Apply 18 in. vacuum. (More than 25 in. vacuum may damage sensor.)

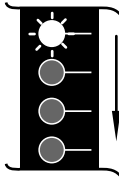

Good Sensor

- TEST light moves downward during engine idle or when vacuum applied. (The TEST light may go off if it moves to the bottom of the column - this is O.K.)
- Range of TEST light movement varies with sensor type and applied vacuum.
- Note: if test results are O.K. but a computer trouble code indicates a bad sensor signal, the wire between the sensor signal pin and the computer may be open.
- Testing is complete.

Problem exists (Bad sensor or wiring)

- TEST light position does not change during test.
- Go to step 9 and continue testing to find cause. Do all steps to avoid replacing a good sensor!

9) Ignition key OFF.

10) Check MAP sensor vacuum hose for...

- Correct hook-up.
- Pinches, kinks or collapsed sides.
- Splits, cuts, breaks or clogs

Repair as necessary, then retest. If no trouble found, go to next step.

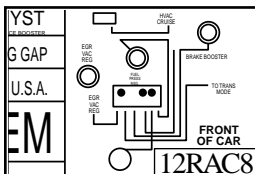

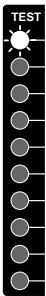
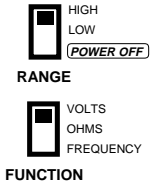

11) Check MAP sensor power circuit.

Keep sensor connected to vehicle wiring.

- YELLOW test lead to sensor POWER circuit. Use backprobe adapter.
- BLACK test lead to good vehicle GROUND.
- RANGE on HIGH.
- FUNCTION on VOLTS.
- Ignition key ON.

Good power circuit: Top (or next to top) TEST light ON.

Go to next step.

Bad power circuit: TEST light OFF or not in top (or next to top) position.

Repair open or short in power circuit wiring, then retest.

12) Check MAP sensor ground circuit.

- Same set-up as previous step, but move YELLOW test lead to sensor GROUND circuit. (Use backprobe adapter.)

Good ground circuit: TEST light OFF.

Go to next step.

Bad ground circuit: Any TEST light ON.

Repair open in ground circuit wiring, then retest.

13) Check for connector problems.

- Ignition key OFF.
- Disconnect wiring harness from MAP sensor. (Some vehicles use a metal snap ring to secure wiring harness to sensor. Remove this snap ring before disconnecting wiring harness.)
- Check terminals for damage, corrosion, bad wire crimps or improper seating in connector.

Repair as necessary, then retest. If no trouble found, go to next step.

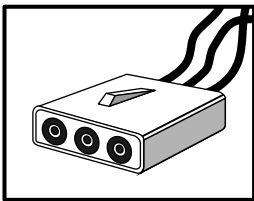

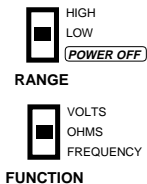

14) Check MAP signal wire for short to ground.

- Verify ignition key OFF and MAP sensor wiring harness disconnected.
- RANGE on LOW.
- FUNCTION on OHMS.
- YELLOW test lead to MAP signal pin on vehicle harness connector.
- BLACK test lead to good vehicle GROUND.

Good circuit (no short): TEST light ON in any position.

Go to next step.

Bad circuit (shorted): TEST light OFF.

Repair short in signal circuit wiring, then retest.

15) Testing is complete.

Verify ignition key OFF. Set RANGE switch to POWER OFF and remove all test leads.

If steps 10 through 14 are all good (but step 8 showed a problem) then the sensor is bad and needs to be replaced.

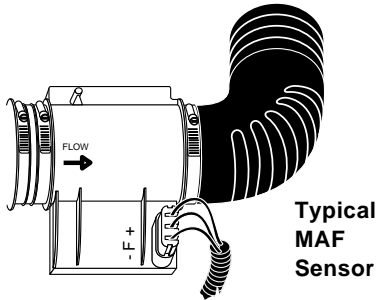

Mass Air Flow (MAF) Sensors

What is It?

This sensor is an electronic module which sends a signal to the computer indicating the amount of air entering the engine. Depending upon sensor type, the signal may be a dc voltage or a frequency. The signal level increases (higher voltage or frequency) as the air flow increases.

Within the sensor is a heated wire located in the path of incoming air. The module determines air flow by measuring the temperature drop of the heated wire as air passes around it.

How it is used?

The computer needs to know incoming air flow to properly adjust air/fuel mixture and ignition timing for varying engine load and operating conditions.

Location

The sensor is mounted in the engine incoming air ducts—typically just behind the air cleaner assembly or near the throttle body.

When to Test

- Related trouble codes sent by computer.
- Driveability problems such as hard starting, rough idle, stalling, hesitation, stumble, surging, knocking (pinging), poor fuel economy, black exhaust smoke, backfiring, catalytic converter overheating or no torque converter lock-up.

Mass Air Flow MAF

Vehicle Harness Connectors for MAF Sensor (Mating side of connector shown.)

GM

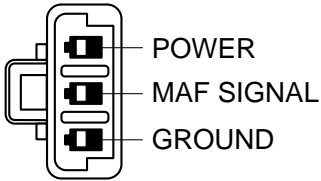

1988 and Older
RANGE on LOW
FUNCTION on FREQUENCY

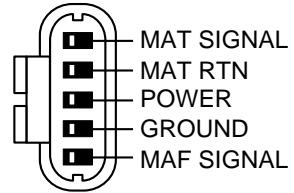

1988 2.8L only
RANGE on LOW
FUNCTION on FREQUENCY

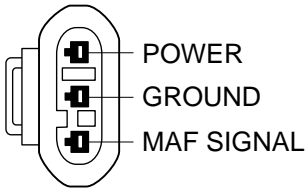

1989 and Newer
RANGE on HIGH
FUNCTION on FREQUENCY

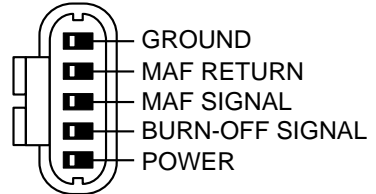

All 5-Pin except 1988 2.8L
RANGE on HIGH
FUNCTION on VOLTS

Ford

NOTE:

MAF RETURN is not connected to vehicle GROUND.

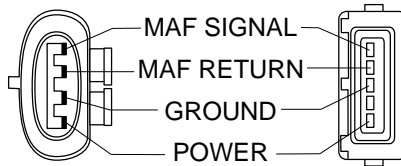

RANGE on HIGH
FUNCTION on VOLTS

Refer to vehicle service manual for connectors not shown.

Vehicle Harness Connectors for MAF Sensor (Mating side of connector shown.)

Nissan

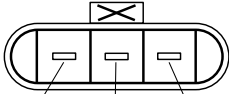

MAF Signal Ground Power

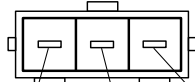

Power Ground MAF Signal



MAF Signal Ground Power

Pulsar NX SE All except 1987-88



MAF Signal Ground Power

1987-88 Pulsar NX SE only

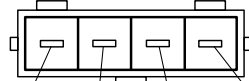

Ground Power MAF Return MAF Signal

1985-86 Maxima 1985-86 300ZX 1985-86 300ZX Turbo

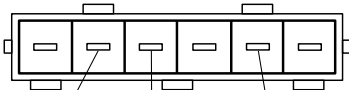

Power Ground MAF Signal

1987 Pulsar NX 1987 Sentra (E16i) 1988 Pulsar NX XE 1988 Sentra

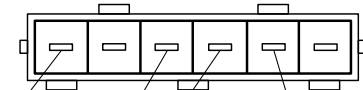

MAF Signal Ground Power

1987-88 Maxima 1987-88 200SX SE 1987-89 300ZX

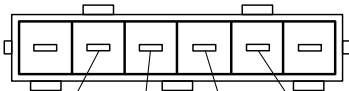

MAF Signal Ground MAF Return Power

1989-90 Sentra 1990 Pulsar NX

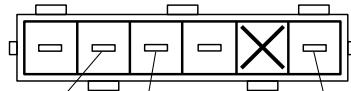

Power Ground MAF Signal

1989 and Up Maxima 1990 and Up 300ZX

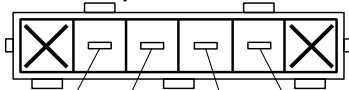

Power MAF Return* Ground MAF Signal

*May not be used

All Nissan:

RANGE on HIGH
FUNCTION on VOLTS

X = May not be used

Refer to vehicle service manual for connectors not shown.

Mass Air Flow (MAF) Sensor Test Procedure

Testing is done on-vehicle.

Warning: *This test involves running the engine. Observe all safety precautions (see page ii). Work in well-ventilated area.*

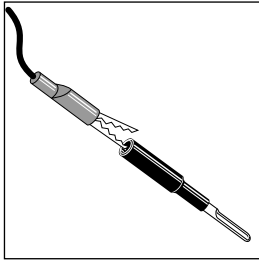

1) Verify ignition key is OFF.

2) Check Tester battery

Refer to page 1-4. Set RANGE switch to POWER OFF when done.

3) Connect test leads - refer to hook-up diagram.

Keep sensor connected to vehicle wiring.

- YELLOW to sensor SIGNAL circuit. Use backprobe adapter.
- BLACK to good vehicle GROUND.

4) Verify test clips make good contact.

Make sure unused clips are not touching anything.

5) Set switches - refer to hook-up diagram.

6) Turn ignition key ON but DO NOT START ENGINE.

7) Note TEST light position on tester.

- Typically, the TEST light will be off, at the bottom of the column or blinking.
- Ignore any PULSE light action.
- If the sensor is good, the light will move upwards during engine run.

8) Start engine and let idle - Watch TEST light for results.

Good Sensor:

- TEST light moves upward after engine starts. TEST light moves up even further if engine RPM is momentarily increased. (Move throttle to check.) Range of TEST light movement varies with sensor type and engine speed.

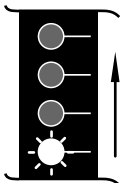

- Note: If test results are O.K. but a computer trouble code indicates a bad sensor signal, the wire between the sensor signal pin and the computer may be open.
- Testing is complete.

Problem exists (Bad sensor or wiring):

- TEST light position does not change during test.
- Go to step 9 and continue testing to find cause.
Do all steps to avoid replacing a good sensor!
- **Note:** Sensor is defective if TEST light jumps erratically when sensor GENTLY tapped with lightweight tool.

9) Ignition key OFF.

10) Check for air intake problems.

- Air leaks - around MAF sensor, ductwork or throttle body.
- Obstructions in air duct.
- Clogged air filter.

Repair as necessary, then retest. If no trouble found, go to next step.

11) Check MAF sensor power circuit.

Keep sensor connected to vehicle wiring.

- YELLOW test lead to sensor POWER circuit. Use backprobe adapter.
- BLACK test lead to good vehicle GROUND.
- RANGE on HIGH.
- FUNCTION on VOLTS.
- Ignition key ON.

Good power circuit: Top (or next to top) TEST light ON.

Go to next step.

Bad power circuit: TEST light OFF or not in top (or next to top) position.

Repair open or short in power circuit wiring, then retest.

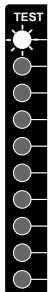
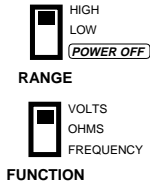
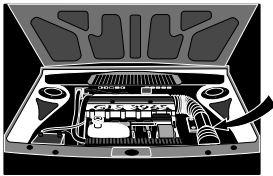

12) Check MAF sensor ground circuit.

- Same set-up as previous step, but move YELLOW test lead to sensor GROUND circuit. **Do not** probe MAF RETURN pin. Use backprobe adapter.

Good ground circuit: TEST light OFF.

Go to next step.

Bad ground circuit: Any TEST light ON.

Repair open in ground circuit wiring, then retest.

13) Check for connector problems.

- Ignition key OFF.
- Disconnect wiring harness from MAF sensor. (Some vehicles use a metal snap ring to secure wiring harness to sensor. Remove this snap ring before disconnecting wiring harness.)
- Check terminals for damage, corrosion, bad wire crimps or improper seating in connector.

Repair as necessary, then retest. If no trouble found, go to next step.

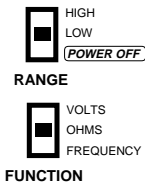
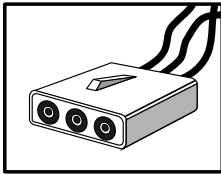

14) Check MAF signal wire for short to ground.

- Verify ignition key OFF and MAF sensor wiring harness disconnected.
- RANGE on LOW.
- FUNCTION on OHMS.
- YELLOW test lead to MAF signal pin on vehicle harness connector.
- BLACK test lead to good vehicle GROUND.

Good circuit (no short): TEST light ON in any position.

Go to next step.

Bad circuit (shorted): TEST light OFF.

Repair short in signal circuit wiring, then retest.

15) Testing is complete.

Verify ignition key OFF. Set RANGE switch to POWER OFF and remove all test leads.

If steps 10 through 14 are all good (but step 8 showed a problem) then the sensor is bad and needs to be replaced.

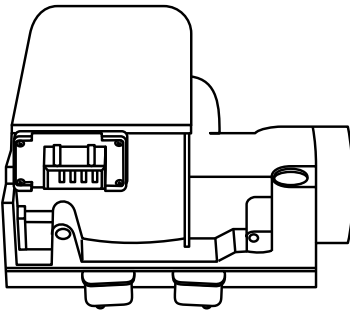

Typical VAF Sensor

AIR FLOW
→

Referred to as Vane Air Flow (VAF) sensor or Air Flow Meter

Vane Air Flow Sensors

What is It?

This sensor sends a dc voltage signal to the computer indicating the amount of air entering the engine. The voltage signal increases as the air flow increases. The sensor assembly has a pivoting door (“vane”) which is opened by incoming air. The vane is connected to a potentiometer (a variable resistor - like a dashboard dimmer control) which generates the voltage signal. Some sensor assemblies also contain an air temperature sensor or a vane position switch (or both).

How it is used?

The computer needs to know incoming air flow to properly adjust air/fuel mixture and ignition timing for varying engine load and operating conditions.

Location

The sensor is mounted in the engine incoming air duct - between the air cleaner and the throttle body.

When to Test

- Related trouble codes sent by computer.
- Driveability problems such as hard starting, rough idle, stalling, hesitation, stumble, surging, knocking (pinging), poor fuel economy, black exhaust smoke, backfiring, catalytic converter overheating or no torque converter lock-up.

What to Inspect

Sensor operation (see tests on pages 2-43 through 2-44). Poor connections at sensor or computer. Faulty sensor wiring (open or short circuits). Airflow obstructions in ductwork or clogged air filter. Binding pivot on vane “door”. Air leaks around sensor or throttle body.

Vane Air Flow VAF

Sensor Connectors

Toyota

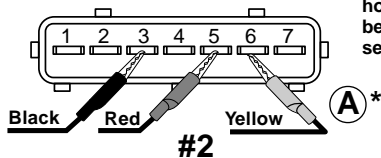
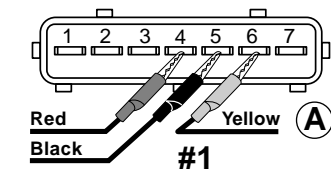

*Toyota uses two sensor types. Try hook-up #1 first. If good test results are not obtained, retest using hook-up #2 before judging sensor.

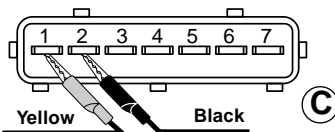
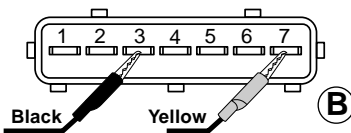

Nissan

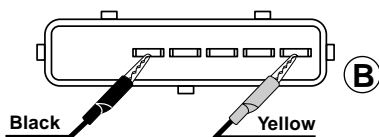
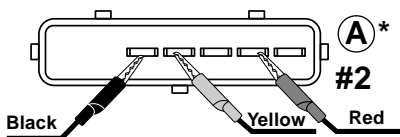
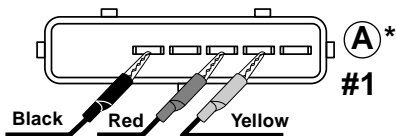

*Nissan uses two sensor types. Try hook-up #1 first. If good test results are not obtained, retest using hook-up #2 before judging sensor.

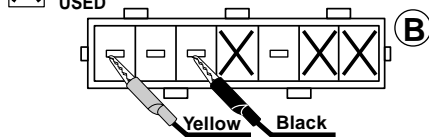
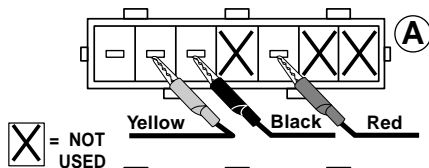

Ford

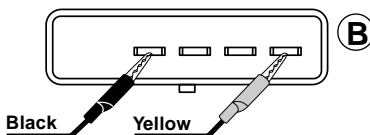
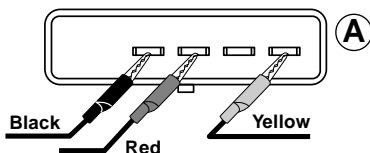

Refer to vehicle service manual for connectors not shown.

Hook up as follows: Red lead to sensor power pin.
Yellow lead to sensor signal pin.
Black lead to sensor ground pin.

TEST PREPARATION:

All Air Flow Meter Sensor Tests**IMPORTANT:**

- Test all hook-ups shown for the sensor.
- The letter next to the hook-up refers to the test procedure for that hook-up.
- Each hook-up should test O.K. **Exception:** *If two hook-ups are marked with an asterisk (*) only one of the two hook-ups has to test O.K. This is necessary because some sensors look alike, but have different internal connections.*

Sensor may be tested on or off vehicle.

Warning: *Observe all safety precautions (see page ii) if testing sensor on vehicle.*

1) Verify ignition key is OFF.**2) Check Tester battery**

Refer to page 1-4. Set RANGE switch to POWER OFF when done.

3) Disconnect wiring harness from sensor - Inspect for damage.

Some vehicles use a metal snap ring to secure wiring harness to sensor. Remove this snap ring before disconnecting wiring harness.

4) Disconnect ductwork from sensor air intake.

This is so you can operate the sensor element for testing. Refer to vehicle service manual for disassembly procedure.

5) Off-Car testing only: Remove sensor.**6) Test Preparation is complete. Do tests referenced in hook-up diagrams.**

- **Test A - Air Flow Meter Sensor** (page 2-43)
- **Test B - Air Temperature Sensor** (page 2-44)
- **Test C - Air Flow Meter Position Switch** (page 2-45)

TEST A - Air Flow Meter Sensor

Warning: Observe all safety precautions (see page ii) if testing sensor on vehicle.

1) Do all Test Preparation steps.

Refer to page 2-42.

2) Connect test leads.

- Connect TEST leads according to diagram A in the component drawing.
- **Important:** If two hook-ups are marked with an asterisk (*) only one of the two hook-ups has to test O.K. This is necessary because some sensors look alike, but have different internal connections.

3) Verify test clips make good contact and do not touch each other.

Make sure unused clips are not touching anything.

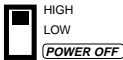

RANGE



FUNCTION

4) Set RANGE switch to HIGH.

5) Set FUNCTION switch to VOLTS.

6) Operate sensor - Watch TEST light for results.

Slowly move the sensor element (pivoting “door” or sliding cone) back and forth from fully closed to fully open position. Use a pencil, or similar object, to push on the “door”. This will not harm the sensor.

Good Sensor - TEST light smoothly moves up or down as sensor is operated. (The TEST light may go off if it moves to the bottom of the column - this is O.K.) Range of TEST light movement varies with sensor type.

Bad Sensor - TEST light position does not change during test OR light movement is erratic, showing a sudden jump or dip during smooth sensor operation.

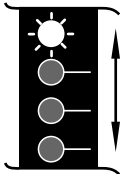

7) Test A is complete.

Set RANGE switch to POWER OFF and remove all test leads. Reconnect sensor to vehicle if all testing is done.

TEST B - Air Temperature Sensor

Warning: Observe all safety precautions (see page ii) if testing sensor on vehicle.

1) Do all Test Preparation steps.

Refer to page 2-42.

2) Connect test leads.

Connect TEST leads according to diagram B in the component drawing.

3) Verify test clips make good contact and do not touch each other.

Make sure unused clips are not touching anything.

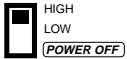

RANGE

4) Set RANGE switch to HIGH.



FUNCTION

5) Set FUNCTION switch to OHMS.

6) Note TEST light position on tester.

If the sensor is good, the light will move downwards as the sensor heats up.

7) Heat temperature sensor thoroughly.

- The air temperature sensor is located either...
 - In a small tube extending into the air intake passage in front of the closed vane “door” OR
 - In its own housing threaded into the side of the air flow meter assembly.
- Heat sensor using a hair dryer or similar device. DO NOT use a match or open flame.

8) Observe TEST light position for test results.

Good Sensor - TEST light moved downwards below original position. (TEST light may go off if sensor is very hot - this is OK.) The TEST light will move upwards as the sensor cools off. Range of TEST light movement varies with sensor type and temperature change.

Bad Sensor - TEST light position did not change during test.

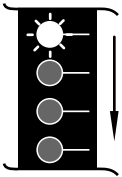

9) Test B is complete.

Set RANGE switch to POWER OFF and remove all test leads. Reconnect sensor to vehicle if all testing is done.

Test C - Air Flow Meter Position Switch

Warning: Observe all safety precautions (see page ii) if testing sensor on vehicle.

1) Do all Test Preparation steps.

Refer to page 2-42.

2) Connect test leads.

Connect TEST leads according to diagram C in the component drawing.

3) Verify test clips make good contact and do not touch each other.

Make sure unused clips are not touching anything.

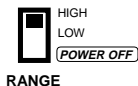

4) Set RANGE switch to HIGH.

5) Set FUNCTION switch to OHMS.

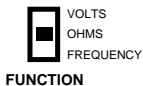

6) Operate sensor - Watch TEST light for results.

Slowly move the sensor element (pivoting “door” or sliding cone) back and forth from fully closed to fully open position. Use a pencil, or similar object, to push on the “door”. This will not harm the sensor.

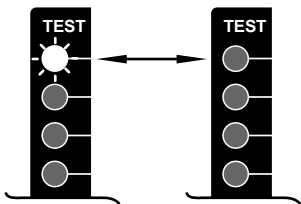

Good Switch - TEST light switches between being ON at top of column and OFF

Bad Switch - TEST light always ON at top of column or always OFF.

7) Test C is complete.

Set RANGE switch to POWER OFF and remove all test leads. Reconnect sensor to vehicle if all testing is done.

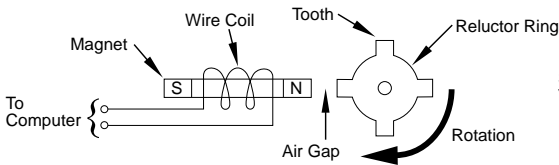

Reluctance Sensor Operation

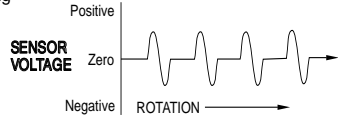

Typical Sensor Signal Voltage

Crankshaft/Camshaft Position sensors

What is It and How is It Used?

— The computer needs to know rotational speed (or position) of the engine crankshaft/camshaft for controlling ignition and fuel injector systems. If the computer is handling a Distributorless (or Direct) ignition system or controlling the operation of individual fuel injectors, it also needs to know when cylinder #1 is active. The sensors have various names such as: *Crankshaft Position*, *Crank Angle*, *Flywheel*, *Distributor Pick-Up*, *Camshaft Position*, *Cylinder*, *TDC* and *RPM*.

— Similar sensors are used in anti-lock brake and electronically shifted transmission systems. These sensors have names such as: *Wheel Speed*, *Vehicle Speed* and *Driveshaft*.

— The sensors come many styles using different connectors. Sometimes an assembly contains more than one sensor. Other versions combine two functions into a single sensor (usually camshaft position and cylinder #1 identification).

— The most common sensor types are *Magnetic Reluctance* and *Hall Effect*. These are described below along with *Optical* types which are in limited use.

• **Magnetic Reluctance**

The basic reluctance sensor consists of a permanent magnet with a coil of wire wrapped around it. Nearby the sensor is a toothed ring made of iron or steel (sometimes called a "reluctor"). The ring is attached to a rotating component such as the crankshaft or camshaft. Whenever a tooth from the ring passes by the sensor, it attracts the magnetic field lines surrounding the magnet. As the field lines move, they pass through the wire coil and generate a small voltage pulse (magnetic induction principle). Thus a voltage pulse is generated every time a tooth passes by the sensor coil.

Crankshaft/Camshaft Position

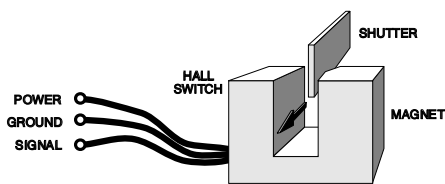

Typical Hall Effect Sensor

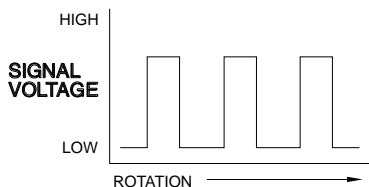

Typical Sensor Signal Voltage

The computer determines rotational speed (or position) by measuring how fast (or when) pulses appear. Note: The voltage pulses get larger when the teeth pass by more quickly. Values can range from a fraction of a volt (crank RPM) to over a hundred volts (high RPM).

- **Hall Effect** The basic Hall effect sensor consists of a permanent magnet and a small module containing a transistorized Hall effect switch. (Power and ground connections are required for operation.) A small air gap separates the sensor and the magnet. The magnetic field causes the Hall switch to turn on and send out a low voltage signal. If a metal strip (iron or steel) is placed in the gap, it blocks the magnetic field from reaching the Hall device. This causes the Hall switch to turn off and send a high voltage signal out on the signal wire.
The metal strips (blades) are part of a disk or cup attached to a rotating component such as the crankshaft or camshaft. As the blades pass through the sensor gap, the voltage signal switches high and low creating a series of pulses. The computer determines rotational speed (or position) by measuring how fast (or when) pulses appear.
- **Optical** The optical crank angle sensor consists of a light source, a light detector (photo-electric cell) and a rotor plate, which is a slotted disk. Since the distributor shaft and/or camshaft are linked to the rotor plate, they move together. As the rotor plate rotates, the slits on the disk interrupt a beam of light sent by the light source to the light detector. This interrupting action creates two pulse waveforms that are monitored by the engine computer. The engine computer uses these waveforms and other engine sensors to optimally control ignition timing.

Where is It?

- Crankshaft Position, Crank Angle, Flywheel, Distributor Pick-Up, Camshaft Position, Cylinder, TDC and RPM. The sensor is usually located inside the distributor (if the engine has one). Vehicles without a distributor have the sensor located in various places around the engine where it can be mechanically linked to the crankshaft or camshaft.
- Driveshaft: Sensor located in transmission housing or near driveshaft.
- Wheel Speed, Vehicle Speed: Sensors on individual wheels, drive shaft, or transmission shaft.

When to Test

- Related trouble codes sent by computer.
- Problems with...
 - Ignition: No start, stalling, rough running.
 - Electronic Transmission: No torque converter lock-up, faulty shifting or slipping.
 - ABS system: Faulty or not working.

What to Inspect

All Sensor Types: Sensor operation (see tests on page 2-49 through 2-52). Poor connections at sensor or computer. Faulty sensor wiring (open or short circuits).

– *Magnetic Reluctance:* Too much gap between sensor coil and reluctor ring. Cracked, broken, or missing teeth on reluctor ring. Note: Some rings may normally have a gap or irregular tooth space. This gives the computer cylinder identification information.

– *Hall Effect:* Foreign objects in gap between Hall sensor and shutter assembly. Cracked, broken, or missing blades on shutter. Note: Some shutter assemblies may normally have irregular blade spacing. This gives the computer cylinder identification information.

– *Optical:* Dirt in the rotor blade slots or light source/detector assembly. Broken or worn teeth on the distributor shaft (if used) or sensor shaft.

Test A - Magnetic Reluctance Type Sensor

Testing is done on-vehicle.

DO NOT test vehicle speed or driveshaft type sensors since they require vehicle motion.

Warning: Observe all safety precautions (see page ii) when testing sensor on vehicle.

1) Verify ignition key is OFF.

2) Check Tester battery

Refer to page 1-4. Set RANGE switch to POWER OFF when done.

3) Disconnect wiring harness from sensor - Inspect for damage.

Some vehicles use a metal snap ring to secure wiring harness to sensor. Remove this snap ring before disconnecting wiring harness.

4) Connect test leads.

Refer to vehicle service manual for sensor pin identification. Some connectors handle more than one sensor. Test all sensors.

- YELLOW to one end of sensor coil pin.
- BLACK to other end of sensor coil pin.

5) Verify test clips make good contact and do not touch each other.

Make sure unused clips are not touching anything.

6) Set RANGE switch to LOW.

7) Set FUNCTION switch to VOLTS.

8) Operate sensor - Watch TEST light for results.

(Note: Ignore any RICH / LEAN light flashes.)

– *Crankshaft/Camshaft sensor:* Crank engine.
STAY AWAY from moving engine parts.

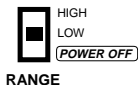

Observe all safety precautions (see page ii) - engine may start or backfire.

Note: Some computer systems will store a trouble code in memory (and turn on the "Check Engine" light) if engine is cranked with sensor disconnected. Ignore or erase the code after testing. Refer to vehicle service manual.

– *Wheel Speed sensor:* Raise wheel off ground. Use jack stands and observe all safety precautions (see page ii). Give the wheel a quick spin in either direction to test.

Good sensor - TEST lights flicker or stay ON during testing. Position and range of TEST light activity varies with sensor type.

Bad sensor - TEST lights OFF during testing.

9) Testing is complete.

Set RANGE switch to POWER OFF and remove all test leads.



Test B - Hall Effect Type or Optical Type Sensor

Sensor may be tested on or off vehicle.

Warning: Observe all safety precautions (see page ii) if testing sensor on vehicle.

1) Verify ignition key is OFF.

2) Check Tester battery

Refer to page 1-4. Set RANGE switch to POWER OFF when done.

3) Disconnect wiring harness from sensor - Inspect for damage.

Some vehicles use a metal snap ring to secure wiring harness to sensor. Remove this snap ring before disconnecting wiring harness.

4) Off-Car testing only: Remove sensor.

5) Connect test leads.

Refer to vehicle service manual for sensor pin identification. Some connectors handle more than one sensor. Test all sensors.

- RED to sensor power pin.
- YELLOW to sensor signal pin.
- BLACK to sensor ground pin.

6) Verify test clips make good contact and do not touch each other.

Make sure unused clips are not touching anything.

7) Set RANGE switch to LOW.

8) Set FUNCTION switch to FREQUENCY.

9) Operate sensor - Watch PULSE light for results.

(Note: Ignore any TEST light action.)

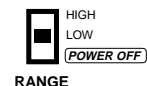



On-Car test: Crank engine. STAY AWAY from moving engine parts. Observe all safety precautions (see page ii) - engine may start or backfire.

Good sensor - PULSE light flashes or stays ON during cranking (varies with sensor type).

Bad sensor - PULSE light OFF during cranking.

Note: Some computer systems will store a trouble code in memory (and turn on the “Check Engine” light) if engine is cranked with sensor disconnected. Ignore or erase the code after testing. Refer to vehicle service manual.

Off-Car test: Slide a flat piece of iron or steel in and out of the sensor slot. Use a scrap piece of sheet metal, knife blade, steel ruler or similar.

Good sensor - Single flash on PULSE light whenever metal is moved in and out of slot. (The flash will occur either when the metal enters the slot or when it is removed - depends upon sensor.)

Bad sensor - PULSE light OFF during testing.

10) Testing is complete.

Set RANGE switch to POWER OFF and remove all test leads.

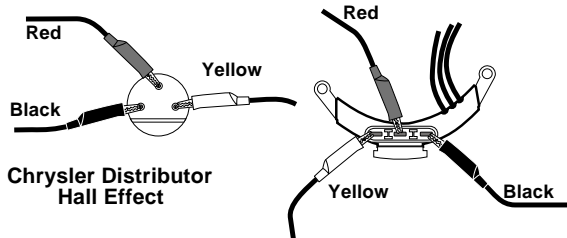

**Ford Distributor Hall Effect
(PIP Sensor, TFI-IV Ignition)**

Testing Ignition Modules

Troubleshooting Tips



Save yourself time! Always begin with a thorough visual and “hands-on” inspection. You can often find the cause of many problems by just looking.

Has the vehicle been serviced recently? Sometimes things get reconnected to the wrong place, or not at all.

Poor grounding can cause no-starts! Some modules make ground connections to vehicle chassis. Check mounting hardware, module flanges and chassis for clean contact surfaces and snug attachment.

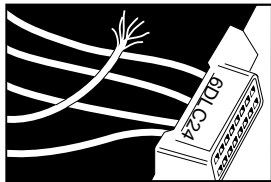

- Inspect wiring for:
 - Contact with sharp edges.
 - Contact with hot surfaces, such as exhaust manifolds.
 - Pinched, burned or chafed insulation.
 - Proper routing and connections.

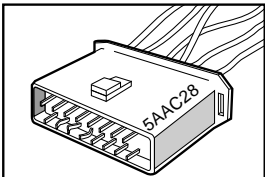

- Check electrical connectors for:
 - Corrosion on pins.
 - Bent or damaged pins.
 - Contacts not properly seated in housing.
 - Bad wire crimps to terminals.
- Check crankshaft/camshaft sensors connected to ignition module. (Refer to page 2-46.)
- Many ignition modules require heat transfer grease applied between module and mounting surface. Modules can overheat and fail if grease is missing or incorrectly applied.

Ignition Module Test Procedure

GM • Ford • Chrysler • Toyota • Honda • Nissan

Important:

- This test checks for “dead” modules causing a no-start. This test will not detect intermittent failures due to heat or engine vibration.
- Refer to vehicle service manual for module location, removal and installation procedures.
 - Module access may require distributor removal. Follow service manual procedures
 - Check ignition timing with a timing light when the distributor is reinstalled.
- Always check the 9 volt battery in the tester (refer to page 1-4).

1) Locate module diagram on preceding pages.

2) Connect test leads as shown.

Begin with the Test 1 hook-up if more than one test is shown.

Always make sure metal clips make good contact and do not touch each other.

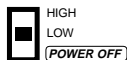

RANGE



FUNCTION



3) Set RANGE switch to LOW.

4) Set FUNCTION switch to FREQUENCY.

5) Observe PULSE light for test results.

- Flashing light means good module. (There may be a short delay before flashing starts.)
- No flashing means bad module.

Note: The bottom TEST lights may also flash. This is normal and may be ignored.

Exception: When testing “ring” type modules (lower half, page 3-11), spin the distributor shaft to activate the PULSE light. (Light on or flashing during spin means good module.)

GM 7 & 8 pin modules only:

- Reconnect test leads as shown in Test 2 diagram.
- Observe PULSE light. It should NOT be flashing. If PULSE light flashes, module is bad.
- Short pins E and R together using paper clip (or other metal jumper).
- Observe PULSE light for test results.
 - Flashing light means good module. (There may be a short delay before flashing starts.)
 - No flashing means bad module.

Ford modules with two test hook-ups:

- Reconnect test leads as shown for Test 2. (Only the Green test lead is moved.)
- Observe PULSE light for test results.
 - Flashing light means good module. (There may be a short delay before flashing starts.)
 - No flashing means bad module.

6) Testing is complete.

Set RANGE switch to POWER OFF and remove all test leads.

GM
4 and 5 pin

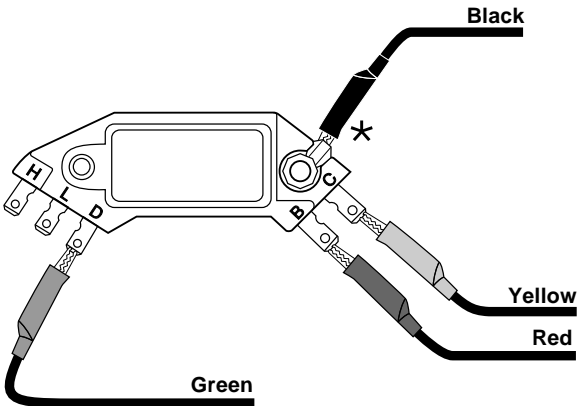
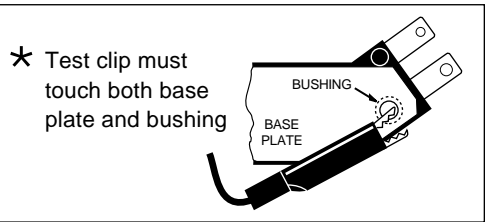
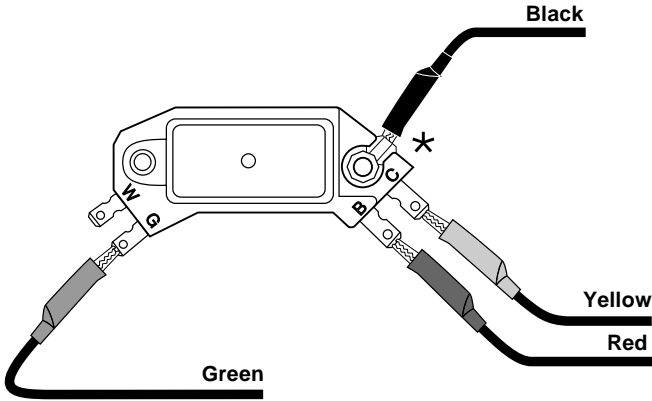

GM
7 pin

Test 1

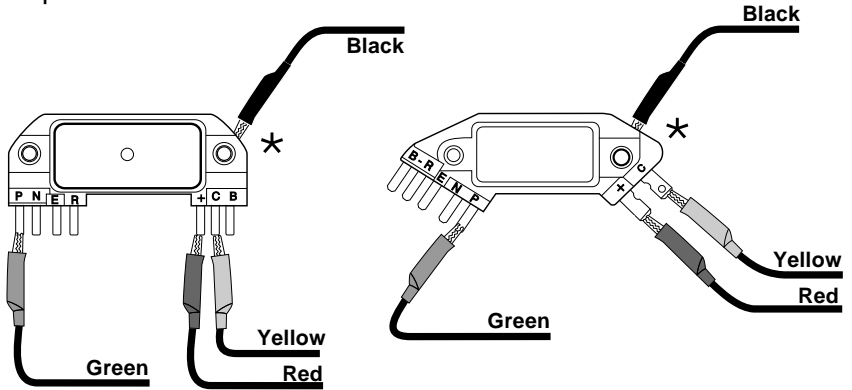

Test 2

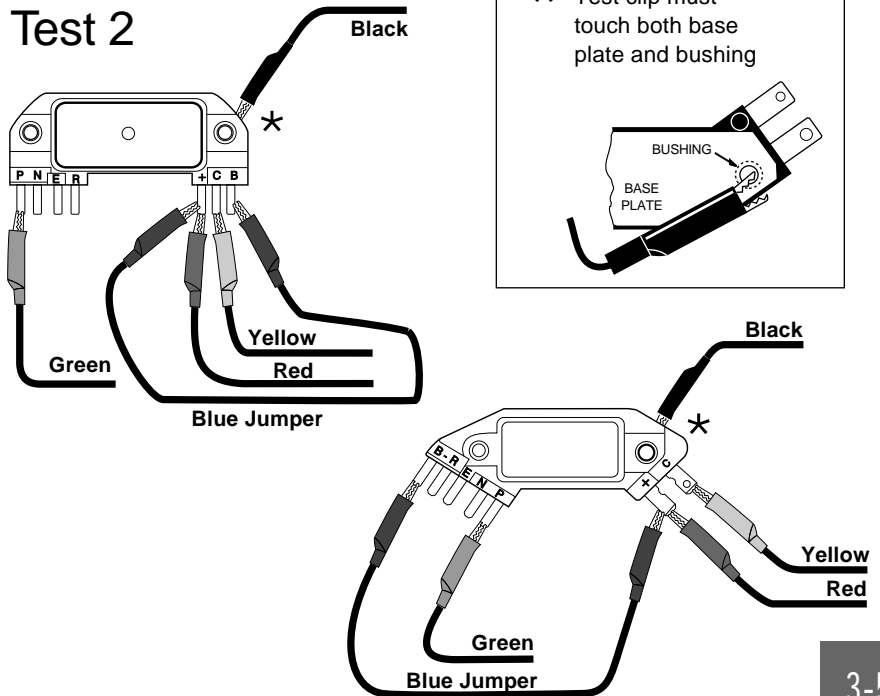

* Test clip must touch both base plate and bushing

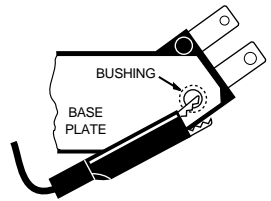

GM
8 pin

Test 1

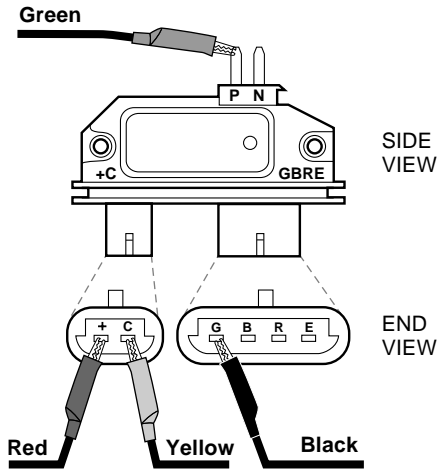

Test 2

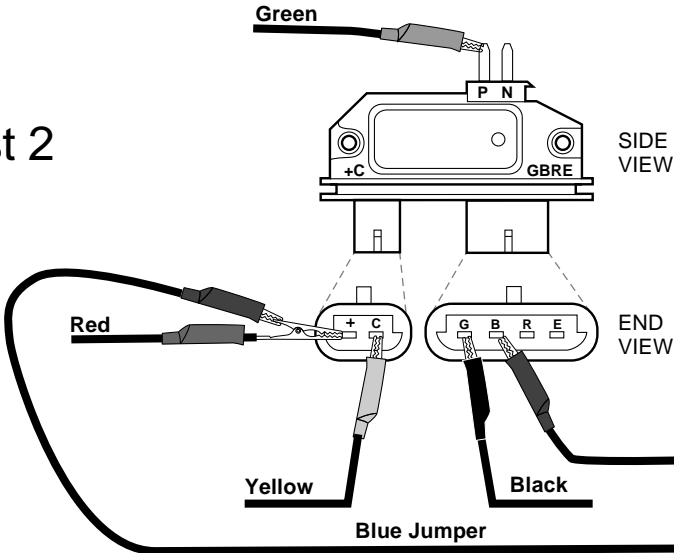

Ford Dura-Spark

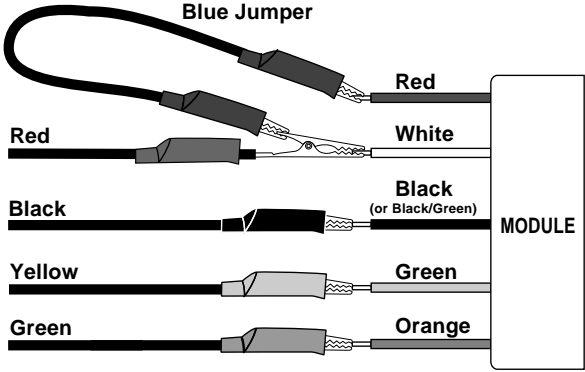

Note: Dura-Spark ignition modules come in several versions with different connector types. Make connections based on ignition module wire colors. Other module wires not used for testing.

Ford TFI

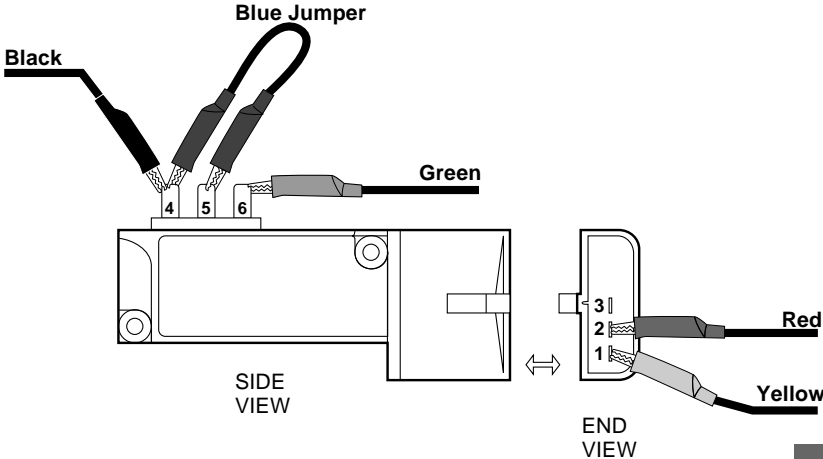

Ford TFI-IV

Test 1: Connect leads as shown.

Test 2: Move Green lead to pin 5.
Other leads remain in original position

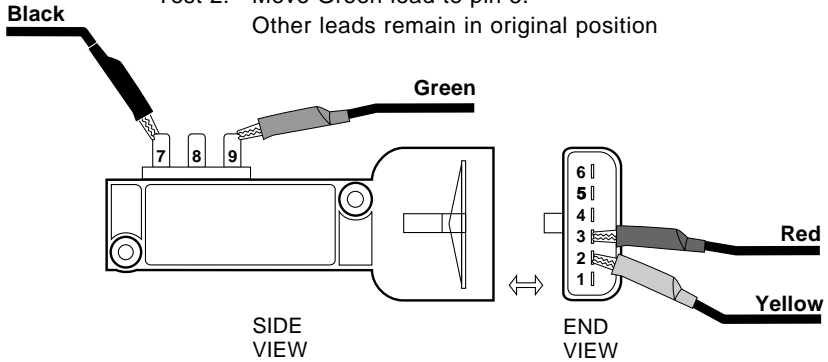

Ford TFI-IV

Test 1: Connect leads as shown.

Test 2: Move Green lead to pin 5.
Other leads remain in original position

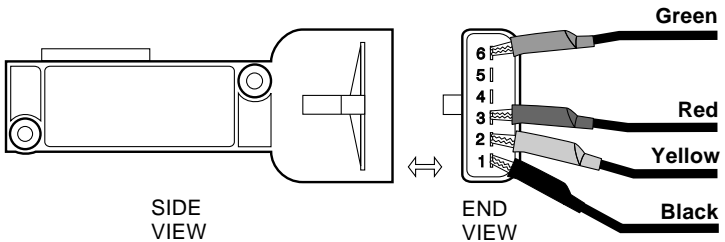

Chrysler 4 and 5 pin

5-pin type shown.
4-pin uses same hook-up.

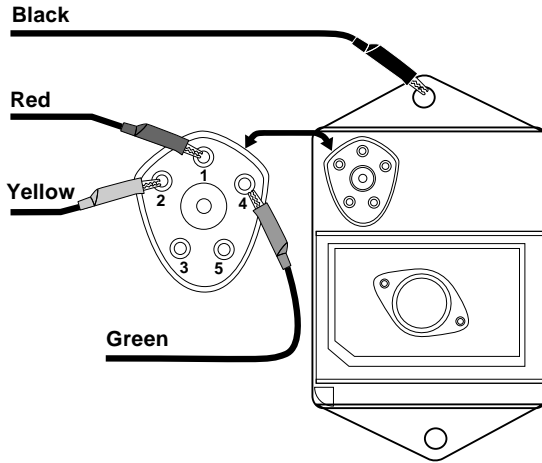

Magnetic Reluctance Pick-up

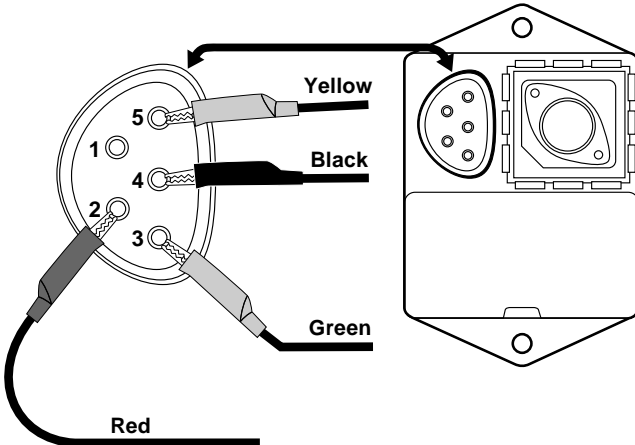

Hall Effect Pick-up

Honda

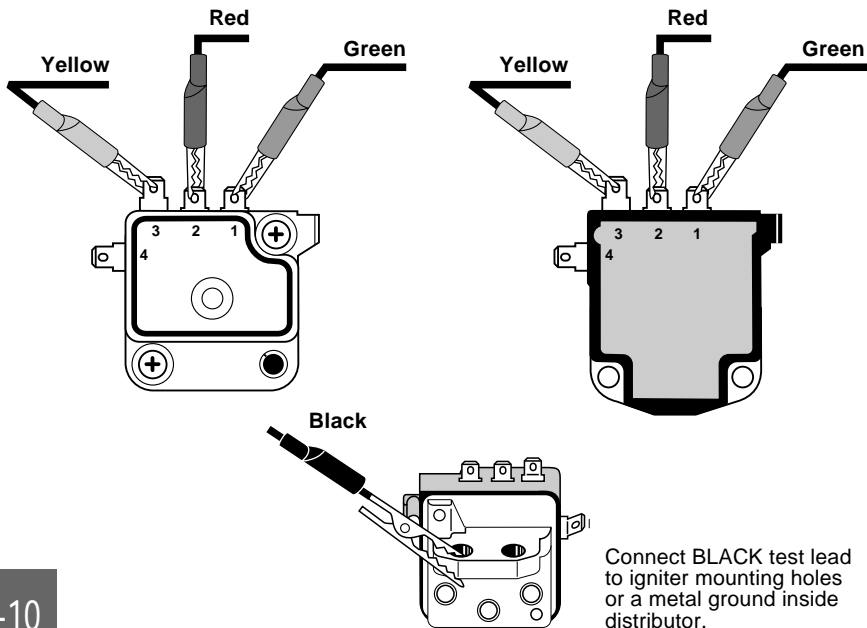
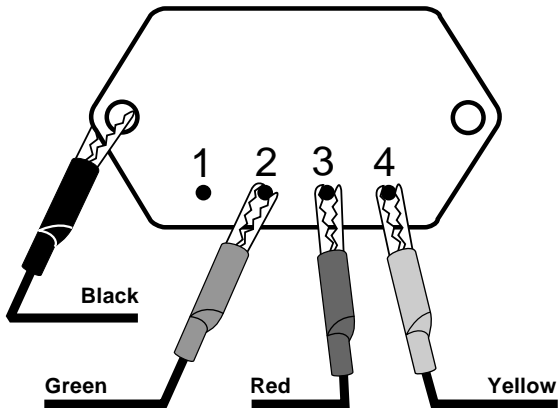

Connect BLACK test lead to igniter mounting holes or a metal ground inside distributor.

Honda/Nissan

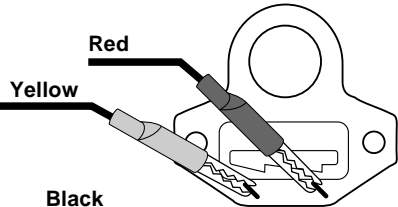
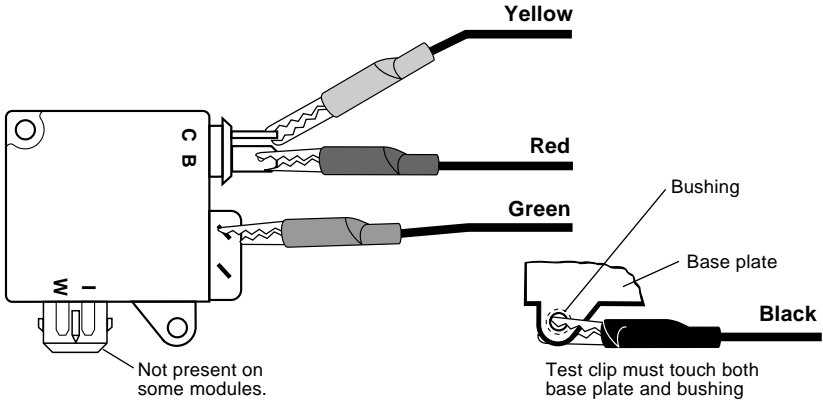

Connect BLACK test lead to a good ground inside distributor.

IMPORTANT

- 1) Remove distributor from engine before testing.
- 2) Module remains inside distributor during test.

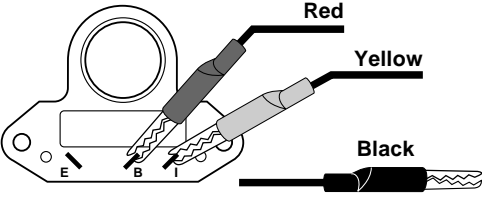

Connect BLACK test lead to a good ground inside distributor.

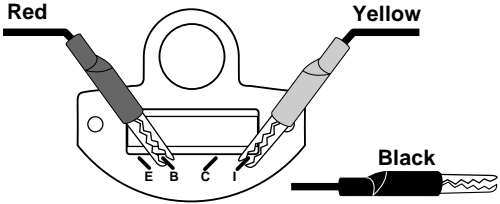

Connect BLACK test lead to a good ground inside distributor.

Nissan

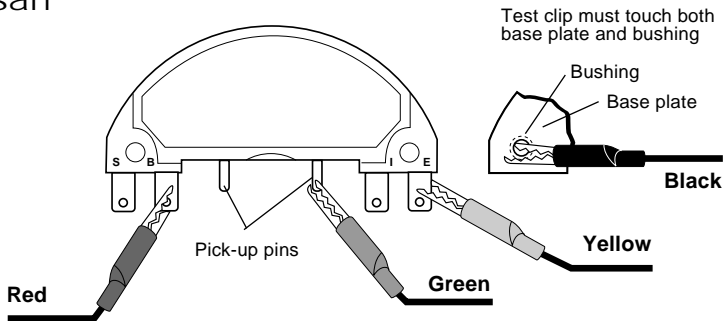

Nissan One-Coil System (Photo pick-up)

1987-1989 300ZX only

* Nissan uses two types of connector wiring. Module is good if either hook-up tests O.K.

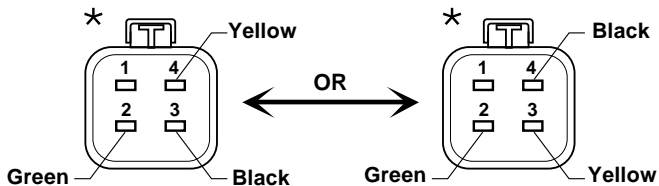
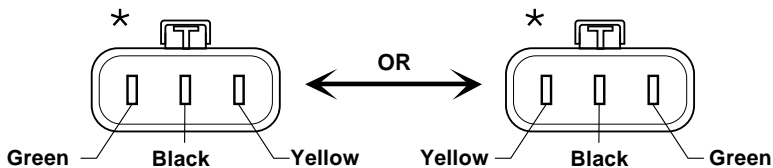
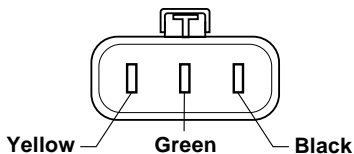

Nissan
Two-Coil System
(Photo pick-up)

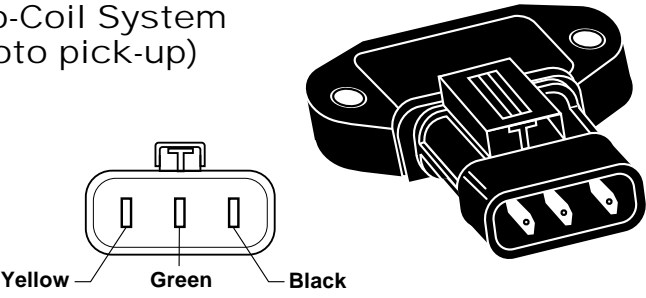

★ Nissan uses two types of connector wiring. Module is good if either hook-up tests O.K.

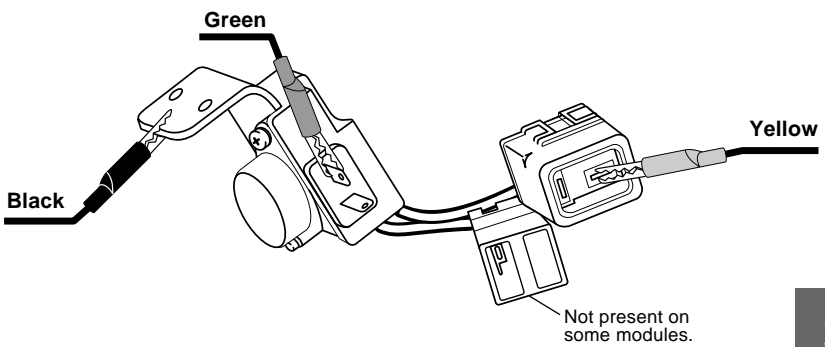
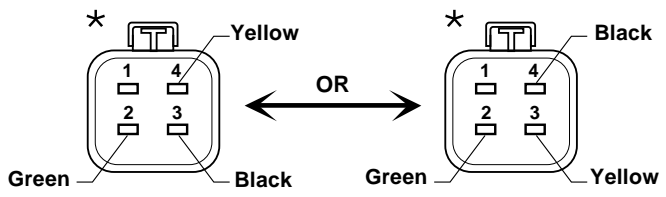

Toyota

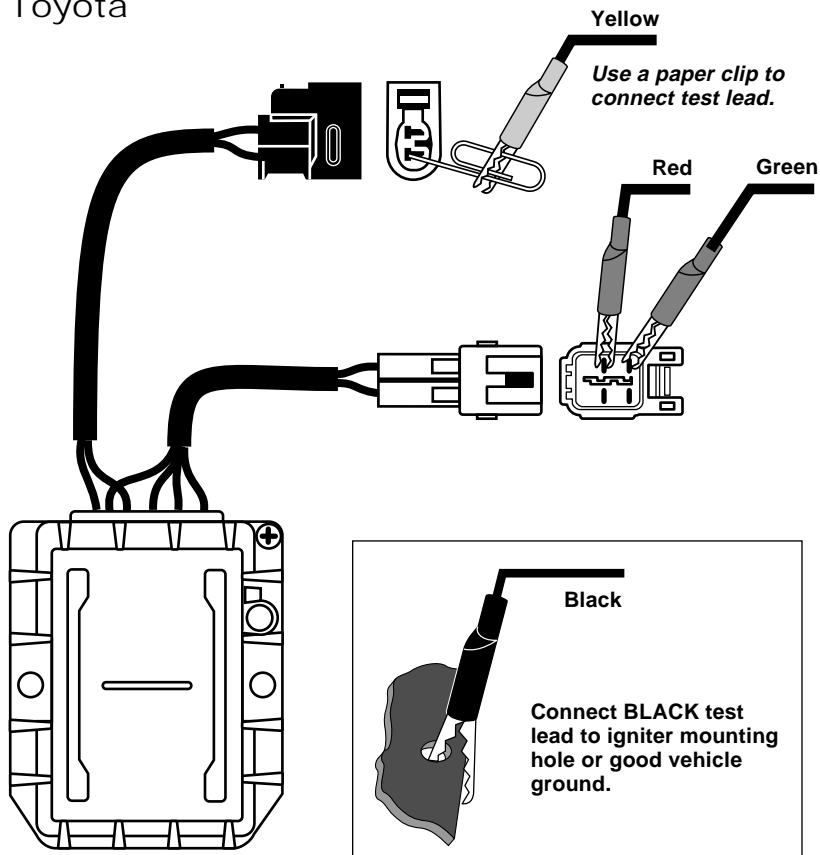
**IMPORTANT**

For Toyota modules not pictured, refer to vehicle service manual and connect as follows:

- Red lead to battery pin
- Yellow lead to coil pin
- Black lead to module ground
- Green lead to IGT pin

Toyota

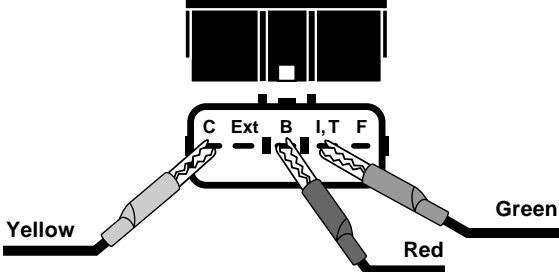
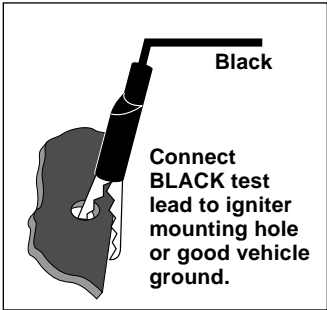
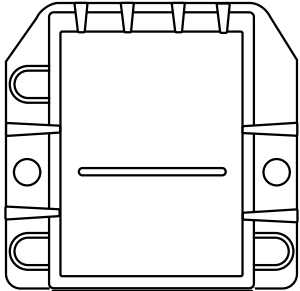
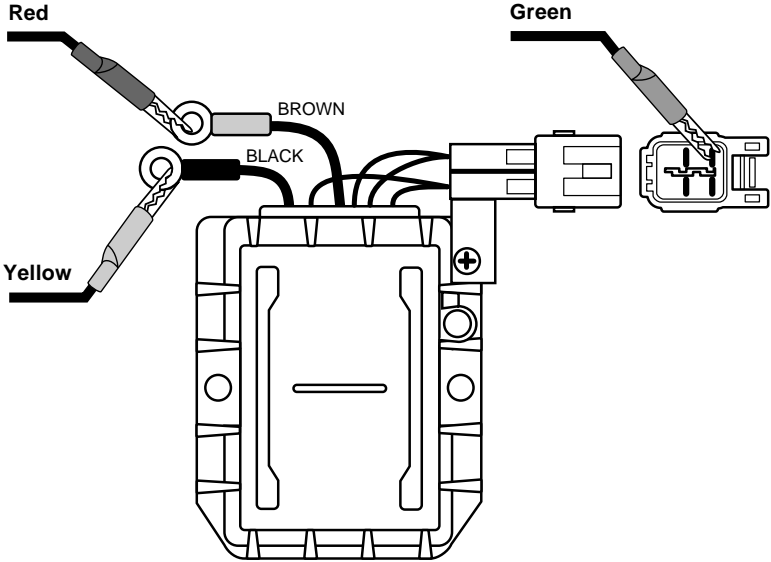

Toyota

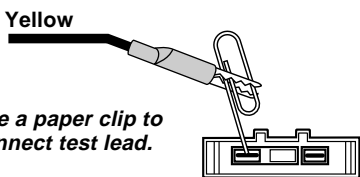
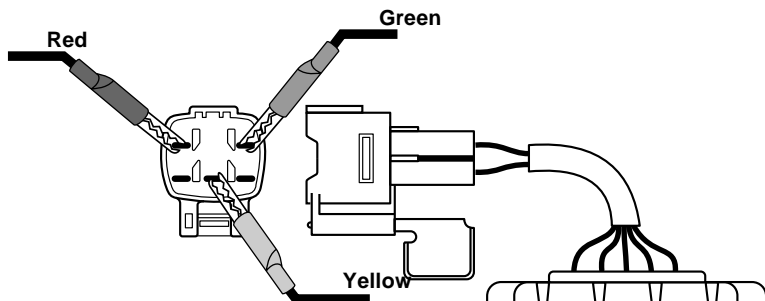

Use a paper clip to connect test lead.

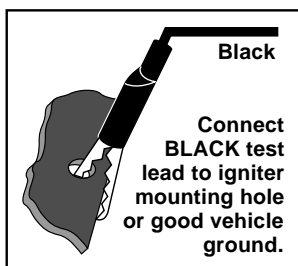

Black

Connect BLACK test lead to igniter mounting hole or good vehicle ground.

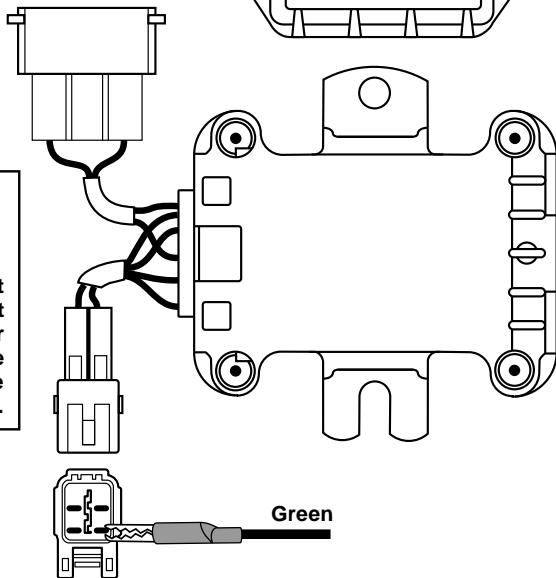

Green

Toyota

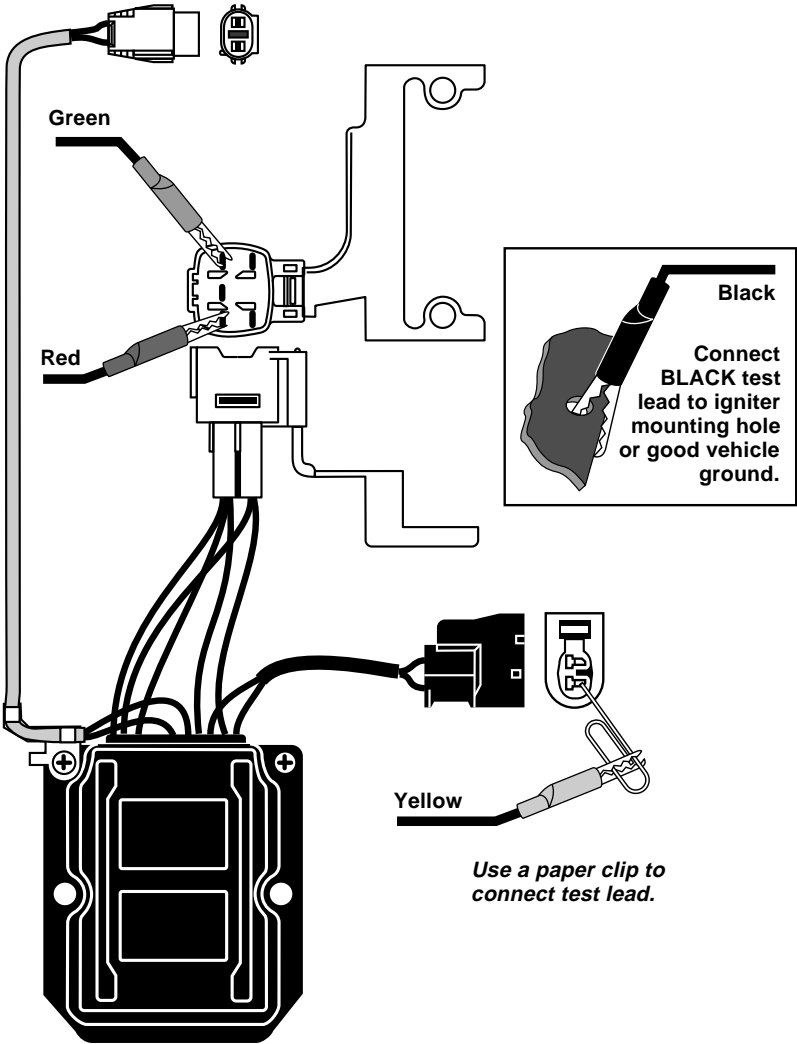

Toyota

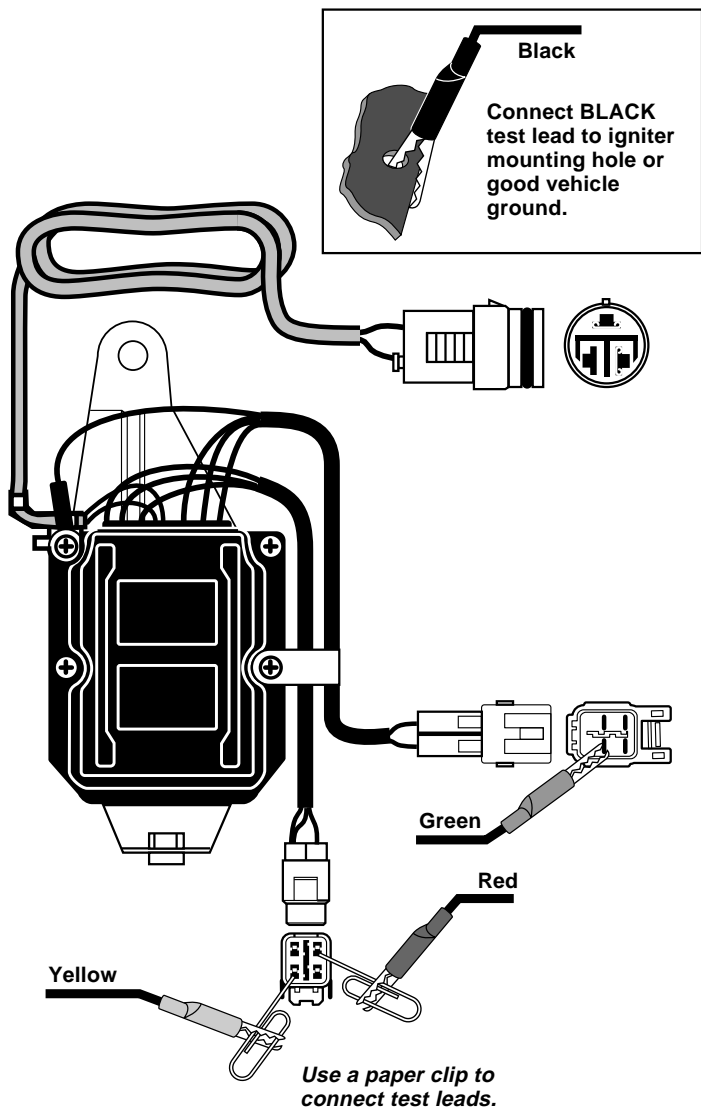

Toyota

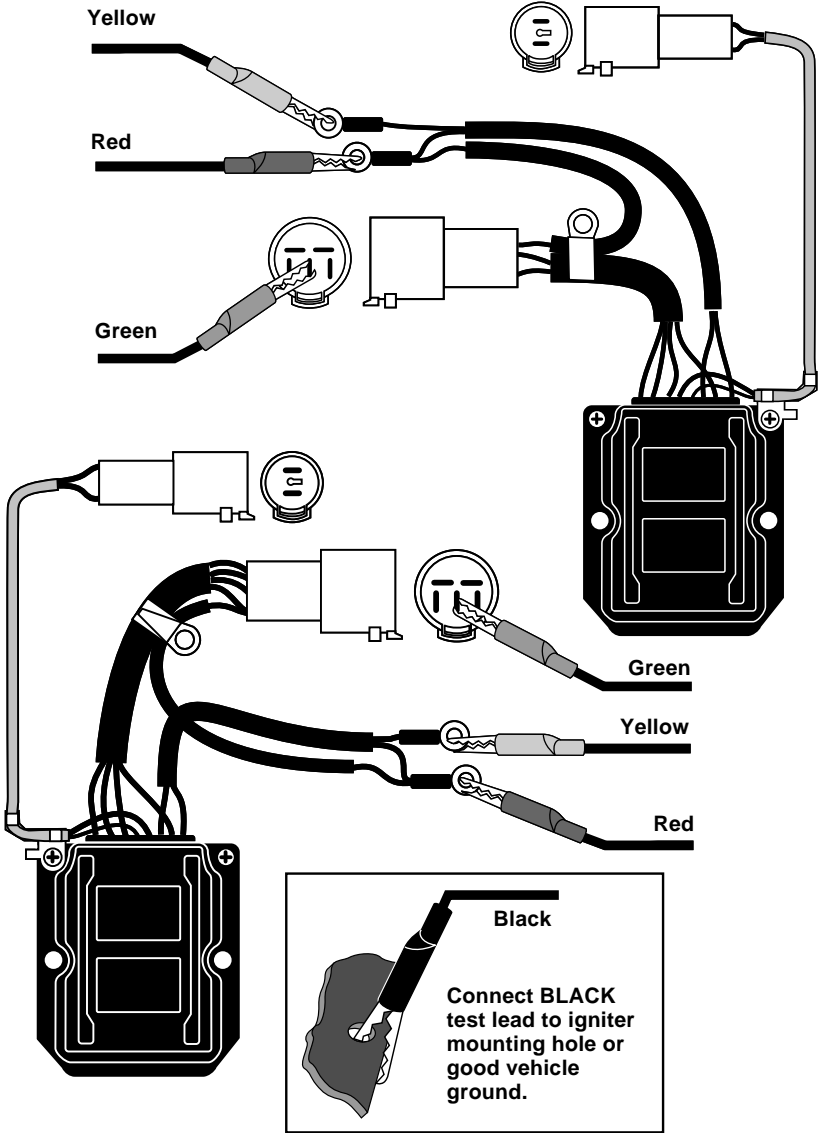

Toyota

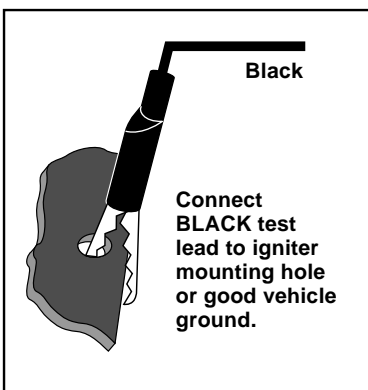
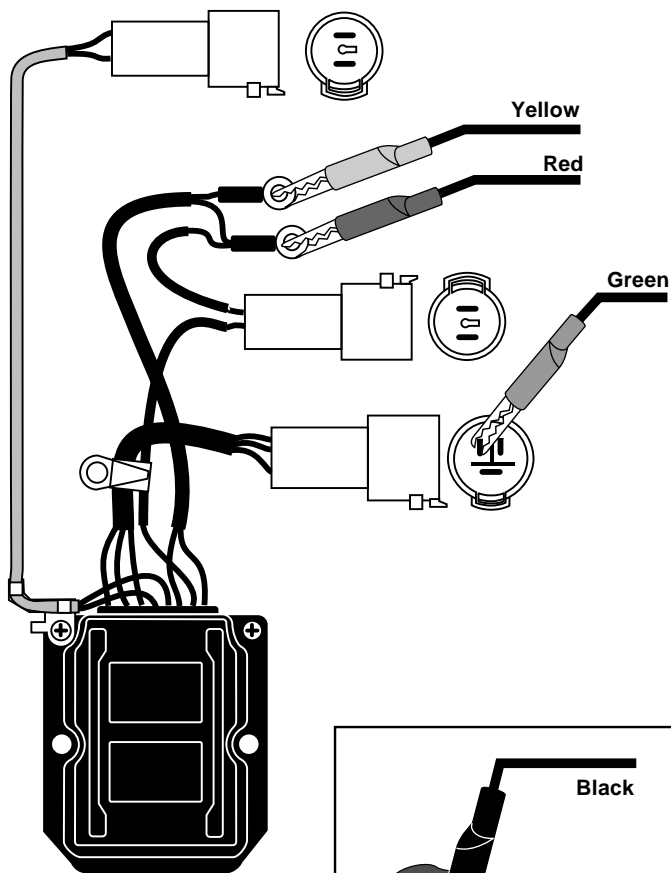

Toyota

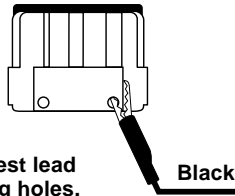
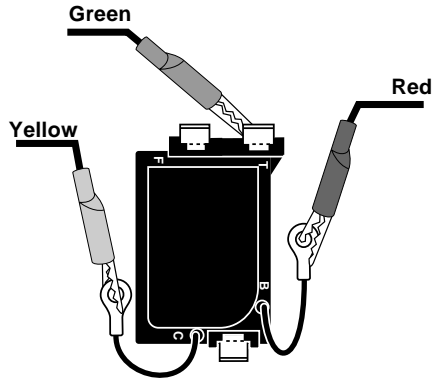
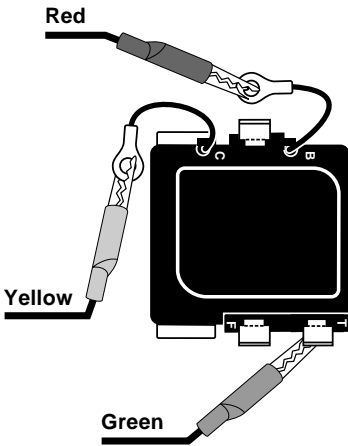
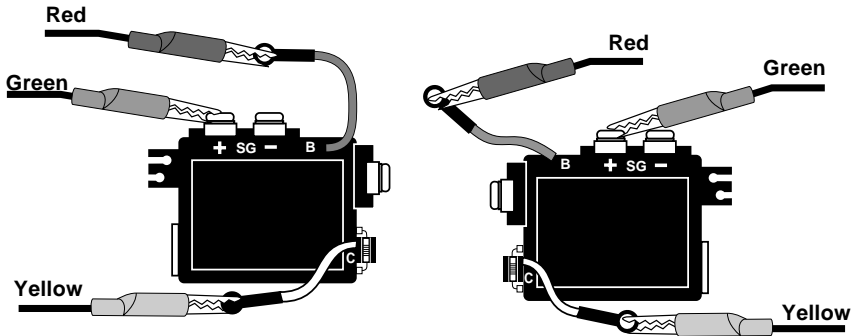

Connect BLACK test lead to igniter mounting holes.

Section

4

More Uses for the Ignition Module & Engine Sensor Tester

Circuit Voltage Checks

This function is useful for checking the presence (or absence) of voltages throughout the vehicle electrical system (such as wiring, switches, relays, and connectors). It is safe for probing computer and sensor circuits.

Warning: Observe all safety precautions when working on vehicles (see page ii).

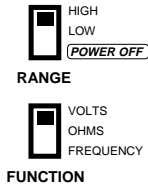

1) Set **FUNCTION** switch to **VOLTS**.

2) Set **RANGE** switch to **HIGH**.

3) Connect **BLACK** test lead to circuit ground.

4) Probe with **YELLOW** test lead.

Warning: Do not connect to secondary ignition circuits - dangerous voltages present!

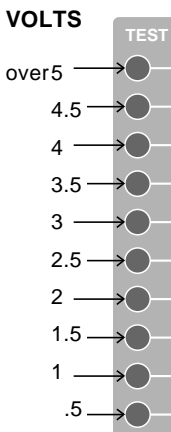

5) TEST light position indicates measured voltage.

Each light represents a 0.5 volt step along a span of 0.5 to 5 volts.

- Top TEST light ON - voltage is 5 volts, or higher.

- Other TEST lights ON - see illustration for voltage level.

- All TEST lights OFF - voltage is less than 0.5 volts, not present or negative polarity.

Important:

- Always make sure all connections are good at the contact points.
- Negative voltages, no matter how large, will NOT turn on TEST lights.
- More than one TEST light on, or jumping around, means the measured voltage is erratic or rapidly changing.

Continuity Checks

Test wiring, ground connections, switch operation, relay contacts, or similar.

Important:

- Do continuity tests on unpowered circuits only.
- Always make sure all connections are good. If necessary, scrape away corrosion, paint, etc. at the contact points.

Warning: If working on-car, turn ignition key OFF and observe all safety precautions (see page ii).

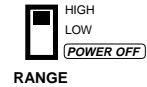

1) Set RANGE switch to HIGH.

2) Set FUNCTION switch to OHMS.

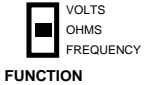

3) Connect YELLOW test lead to one end of circuit (such as wire, switch or relay contact).

4) Connect BLACK test lead to other end of wire, switch or relay.

5) TEST light position indicates amount of continuity.

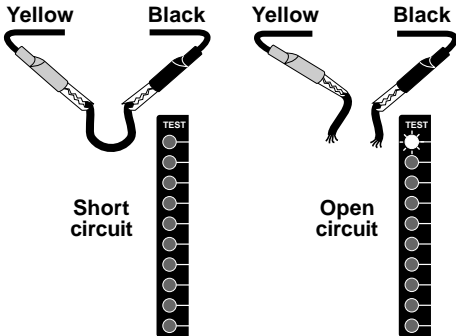

- All TEST lights OFF - Short Circuit (measured resistance is 200 ohms, or less).

- Top TEST light ON - Open Circuit (measured resistance is 7 Kohms, or higher).

Other TEST lights ON mean circuit has resistance between 200 ohms and 7 K ohms.

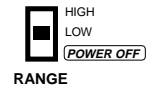

Low Resistance Checks

- RANGE switch on LOW.
- FUNCTION switch on OHMS.
- Use YELLOW and BLACK test leads.

All TEST lights OFF - resistance is 30 ohms, or less.

Top TEST light ON - resistance is 300 ohms, or higher.

Other TEST lights ON mean resistance is between 30 ohms and 300 ohms.

More Uses for the Ignition Module/Sensor Tester

Continuity Checks (cont.)

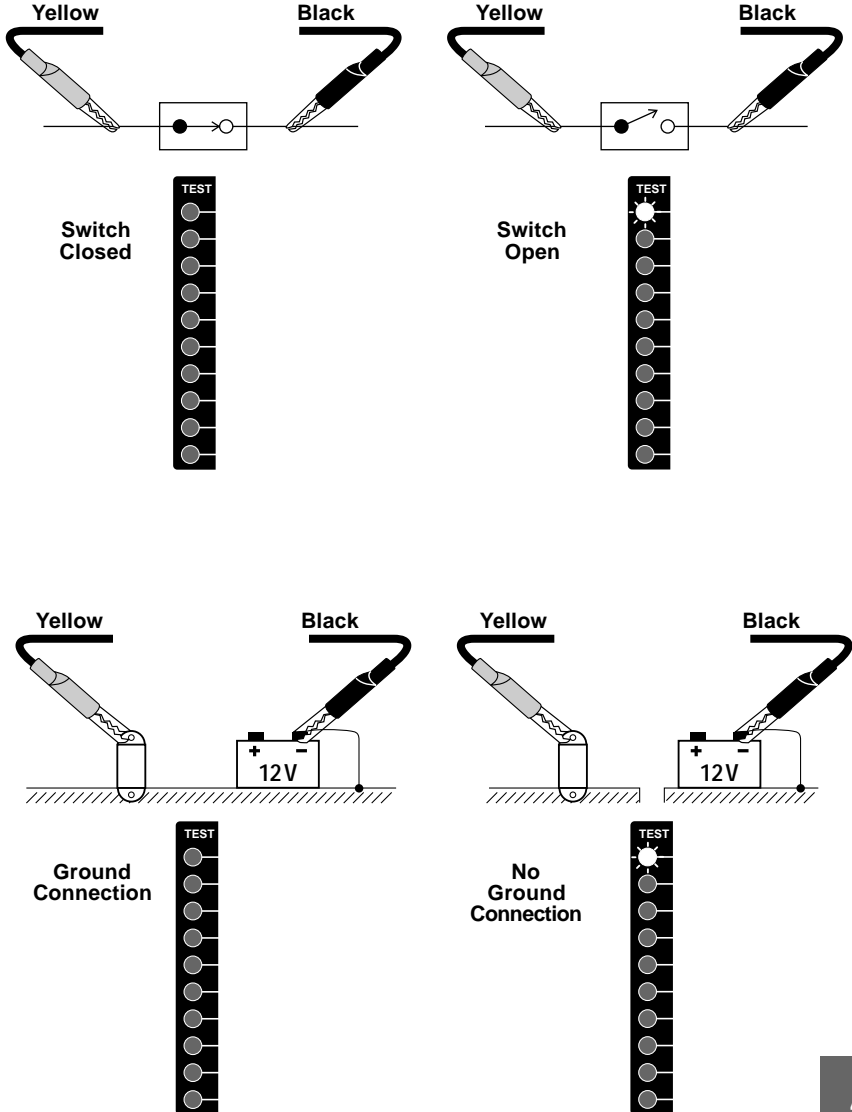

Diode Checks

Tests diodes and rectifiers for proper operation.

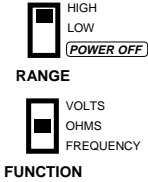

- 1) Set RANGE switch to HIGH.
- 2) Set FUNCTION switch to OHMS.
- 3) Connect TEST leads as shown in Figure 1.
(YELLOW to anode — BLACK to cathode)
- 4) The **bottom** TEST light should be ON. If a different TEST light is on or all lights are off, the diode is defective.
- 5) Reverse test lead connections as shown in Figure 2.
(YELLOW to cathode — BLACK to anode)
- 6) The **top** TEST light should be ON. If a different TEST light is on or all lights are off, the diode is defective.

Note: Always make sure all connections are good. If necessary, scrape away corrosion, paint, etc. at the contact points.

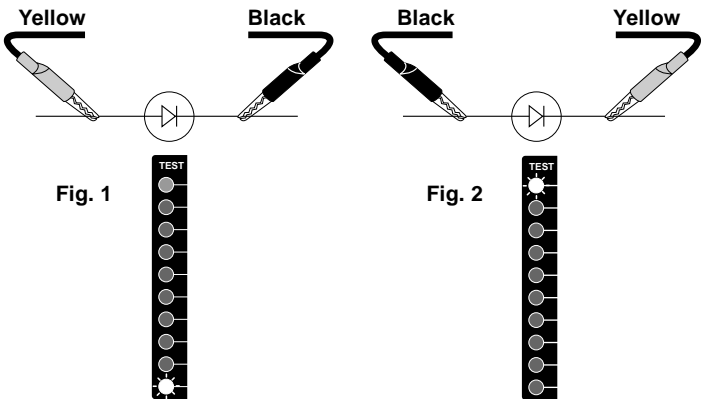

Warranty (Garantia)

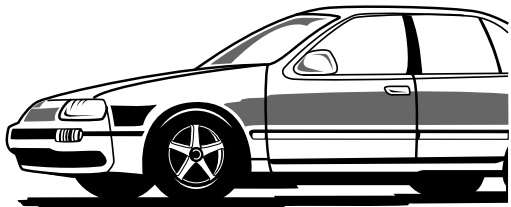

FULL ONE (1) YEAR WARRANTY

Actron Manufacturing Company, 9999 Walford Avenue, Cleveland, Ohio 44102-4621, USA warrants to the user that this unit will be free of defects in materials and workmanship for a period of one (1) year from the date of original purchase. Any unit that fails within this period will be repaired without charge when returned to an authorized factory repair center. Actron requests that a copy of the original, dated sales receipt be returned with the unit to determine if the warranty period is still in effect. This warranty does not apply to damages caused by accident, alterations or improper or unreasonable use. Expendable items, such as batteries, fuses, lamp bulbs and flash tubes are also excluded from the scope of this warranty. Actron Manufacturing Company disclaims any liability for incidental or consequential damages for breach of any written warranty on the unit. Some states do not allow the disclaimer of liability for incidental or consequential damages, so the above disclaimer may not apply to you. This warranty gives you specific legal rights and you may also have rights which vary from state to state.

All information, illustrations and specifications contained in this manual are based on the latest information available from industry sources at the time of publication. No warranty (expressed or implied) can be made for its accuracy or completeness, nor is any responsibility assumed by Actron Manufacturing Company or anyone connected with it for loss or damages suffered through reliance on any information contained in this manual or misuse of the accompanying product. Actron Manufacturing Company reserves the right to make changes at any time to this manual or accompanying product without obligation to notify any person or organization of such changes.

Customer Service Centers

Actron Manufacturing Company

9999 Walford Avenue
Cleveland, Ohio 44102-4621
USA

Tel: +1-261-651-9200
Fax: +1-216-651-2853

Product Information & Repair

Actron - Europe

Coppen Road, Dagenham,
Essex RM8 1NU
UNITED KINGDOM

Tel: +44-(0)181-984-8855
Fax: +44-(0)181-984-8866

Product Information & Repair

Actron - Europe

60 Rte de St Gemme
78860 St NOM LA BRETECHE
FRANCE

Tel: +33-1-30802205
Fax: +33-1 30802182

Product Information Only

actron ®

Actron Manufacturing Company
9999 Walford Avenue
Cleveland, Ohio 44102-4696

©1997, Actron Manufacturing Company

Made in the U.S.A.

Part No. 2-221301