

Contents

WARRANTY	4
INTRODUCTION	5
TEC HARDWARE	5
TEC-I.....	5
TEC-II	6
SOFTWARE OPTIONS	7
Hot Keys and Help Screens	8
FUEL INJECTION FUNDAMENTALS.....	9
DIRECT IGNITION SYSTEM (DIS).....	11
PRE-INSTALLATION CHECK LIST.....	13
TEC INSTALLATION	13
TRIGGER WHEEL & SENSOR INSTALLATION	14
REDESIGNED TRIGGER WHEEL PROFILES (AS OF APRIL '99)	15
Camshaft/Distributor Trigger Wheel	16
Magnetic Sensor	16
Honda TEC II Kit Installation Instructions	17
Neon TEC II Kit Installation Instructions	19
Tips in Removing the Neon's Stock Engine Management Computer	22
Installing the DOHC Only Camshaft Trigger Wheel Bolt-on Kit	23
Installing the DOHC Optional, SOHC Included Crankshaft Trigger Wheel Bolt-on Kit	23
BOLT-ON TRIGGER WHEEL AND BRACKET KITS	25
Small Block Chevy and Ford	25
Trigger Wheel And Bracket For The Volkswagen Type 1	26
Jeep 258 cid Crank Trigger Installation	26
GENERAL FUEL INJECTION LAYOUTS	28
FUEL INJECTOR SELECTION AND SIZING	29
POWER AND GROUND CONNECTIONS	30
GROUNDS	30
+12 VOLT POWER	30
FUSES	30
SPECIAL NOTES ON DYNO USE	31
SPARK PLUGS, AND SPARK PLUG WIRES.....	31
Spark plug type and gap	31
SPARK PLUG WIRING ORDER	31
Common Firing Orders	32
Spark Plug Wires	32
ROTARY APLICATIONS	33



INJECTOR CONNECTIONS	34
4 & 6 CYLINDER TEC-II	34
8 CYLINDER TEC-II	34
TEC-I 6 CYLINDER DUAL PLUG, 12 CYLINDER AND TEC-R88	34
THROTTLE BODY INJECTION WIRING TIPS	35
TEC SENSORS	36
MANIFOLD ABSOLUTE PRESSURE (MAP)	36
MASS AIR FLOW (MAF) SENSOR	36
COOLANT (CLT)	37
MANIFOLD AIR TEMPERATURE (MAT)	37
HEATED EXHAUST GAS OXYGEN SENSOR (HEGO)	37
EGO SENSOR (UNHEATED)	37
THROTTLE POSITION SENSOR (TPS)	38
KNOCK SENSOR (OPTIONAL)	38
OUTPUT DEVICES	38
IDLE AIR CONTROL (IAC) MOTOR	38
FUEL PUMP RELAY INSTALLATION	39
TEC-I Only	39
TEC-II Only	39
CHECK ENGINE LIGHT	40
Failure codes which can be set by the TEC:	40
GENERAL PURPOSE OUTPUT (GPO)	40
WIRING DIAGRAMS	40
TEC I, 6 CYLINDER DUAL PLUG	41
TEC I, 12 CYLINDER	42
TEC I, 12CYLINDER USED AS 3 ROTOR SYSTEM	43
TEC R-88	44
TEC II, 4 & 6 CYLINDER	45
TEC II, 8 CYLINDER	46
TEC II, 4 CYLINDER DUAL PLUG (SINGLE AND DUAL SENSOR)	47
HPV 3B	48
WORKING WITH THE CALIBRATION SOFTWARE	49
PC SELECTION	49
System Requirements	49
Windows Users	49
Communications Port Selection	49
COMPUTER BASICS	49
Minimum Required Hardware	49
Compatibility	50
Running the Calibration Software	50
Edit an Existing Calibration	50
View an Existing Data File	50
Program TEC	51
Monitor Engine Functions	51

Print Calibration File	51
Display Files	51
DOS Access	51
Data Graphics	51
Exit to System	51
COMMUNICATIONS	52
Computer Hook-Up Cable	52
Communications Port Selection	52
Power Up	52
COM ERROR	54
BEFORE YOU START THE ENGINE	54
1. FIRING SCHEME	54
2. NUMBER TO DIVIDE TACH BY	54
3. TIME ON FOR ONE GAMA (TOG)	55
A. Selecting a starting TOG (Time on for one GAMA)	55
B. Adjustments to TOG	55
4. INJECTOR OFFSET TIME (IOT)	55
5. MINIMUM TURN-ON TIME FOR INJECTORS	56
6. MAP OFFSET AND AUTO MAP CAL (NOTE: DO NOT USE THIS FEATURE)	56
7. IGNITION ADVANCE	56
8. BLEND	58
GETTING STARTED AND OTHER TUNING TIPS	60
1. Observe the idle mixture	60
2. Adjust the idle parameters to achieve a smooth idle	60
3. Setting the throttle plates	61
4. Preliminary acceleration enrichments	61
5. Load Test the engine and verify adequate fuel delivery	61
6. Set your VE's	61
7. More (or less) Enrichments	62
8. Cold Start	62
9. EGO Parameters	62
10. Special Considerations for Mass Air Flow Sensor tuning	64
11. Tuning the Knock Sensor	64
12. Rev Limiters	66
TROUBLESHOOTING GUIDE	68
CHECK ENGINE FAULT CODES:	70
DATA LOGGING	71
SPECIAL PARTS AND CUSTOM APPLICATIONS FOR TEC'S	73
NITROUS OXIDE RETARD SYSTEMS	73
1. KNK for Single Stage Nitrous systems	73
(Requires Internal Modification to TEC)	73
2. Using the coolant advance table for multiple stage nitrous systems	73



Direct Sales and Our Value Added Dealers

Electromotive products are sold either direct or through our Value Added Dealers (VADs). Electromotive works closely with a network of independent dealers throughout the world. These dealers supplement our products with their experienced installation and calibration skills for specific applications. Combined with their discounts and expert knowledge, it can often be more effective to purchase a system from a VAD instead of directly from Electromotive.

WARRANTY

1year limited warranty covers material and workmanship

All warranty claims must be pre-approved by the factory. Please call for return authorization and instructions. Customer is responsible for the return of defective units to Electromotive. All units in need of warranty repair should be sent "Attention: Service Department" along with a copy of the original invoice to the address shown below. The service department will repair or replace units at their discretion. A service charge will be assessed on units with no trouble found or units found to be damaged due to customer misuse.

Repairs & Returns

An RMA number is required for all units returned to Electromotive in need of repair.

The shipping address is:

Electromotive, Inc.

Attention: Service Department

9131 Centreville Road

Manassas VA 20110-5208

On overseas returns, it is very important to label the outside of the box "MADE IN USA" and "DAMAGED GOODS TO BE REPAIRED". If you do not label it this way, you will be responsible for US import duties if so charged.

Customer is responsible for all shipping charges. Include a detailed note outlining the problems encountered and how you can be contacted. Please be aware that a minimum service charge will be assessed for testing, even if no trouble is found. All returns require pre-approval by the factory and are subject to a 20% restocking charge.

Pricing Policies

All prices subject to change. Wholesale pricing will be extended to automotive businesses only. A copy of the business license and a commercial phone listing are required. Discounts are based on quantity purchases or repeated purchases over 12 months. Discounts do not apply to individual orders under \$250.- nor to Software Licenses.

Software Licenses

All Electromotive products are proprietary and are patented, have patents pending and/or are copyrighted. Electromotive licenses calibration software on a contract basis to qualified users who agree to protect our proprietary interests. The licensee is required to sign an agreement with the company. Software licenses must be signed by the user and be approved by Electromotive before software sales and delivery can be made.

ELECTROMOTIVE CALIBRATION SOFTWARE IS NOT TRANSFERABLE!

NOTE: Unless Identified with a C.A.R.B. E.O.#, Electromotive products are not intended for use on emissions controlled vehicles, and are not intended to be operated on public roads.

INTRODUCTION

Electromotive would like to take this opportunity to congratulate you on your decision to take back control of your Engine in today's high tech environment.

Your first installation and calibration of a complete TEC Engine Control System will introduce you to the same systems that automotive engineers use to develop the controls for OEM vehicles. The first step in becoming an expert engine tuner is to familiarize yourself with this manual. The manual will take you through an overview of the hardware and software, theory of operation, installation, calibration and troubleshooting.

TEC HARDWARE

TEC-I

Electromotive's TEC-I series of controllers are severe duty Total Engine Control systems designed primarily for special racing applications. This configuration allows for separation of the main processor from the coil packs or DFUs and isolates the voltage supply for the fuel pump and injectors from the TEC. This will make it possible to remote mount the TEC and have only the DFUs in the engine bay. All connections are extra duty spade type or are hard wired with weather pack style connectors. TEC-I controllers are currently offered in the following configurations:

TEC-R88

This configuration is designed to accommodate super high performance 8 cylinder engines equipped with very large injectors requiring more than normal amperage to run, or engines using two injectors per cylinder.

TEC-I 6 cylinder dual plug

Having two spark plugs per cylinder is an edge that Porsche racers have taken advantage of for many years and now the dual plug TEC-I is also equipped with six separate injector drivers for up to 12 peak and hold style injectors.

TEC-I 12 cylinder

The twelve cylinder TEC-I splits the magnetic sensors for the DFUs (coil packs) allowing for the timing difference between the two banks of 6 cylinders.

TEC-I for 3 rotor applications

Rotary engines utilize a separate coil for each spark plug and the three rotor applications are available for split timing and simultaneous firing of the leading and trailing spark plugs. These can also be built to have staged injector firing capabilities.

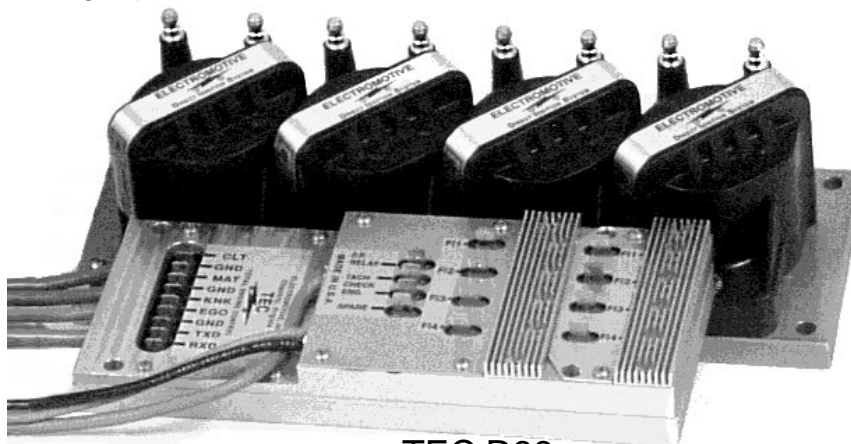

TEC R88

TEC-II

The TEC-II Total Engine Control makes a complete engine management system an easy retrofit for any number of applications. This single chassis design incorporates the power up relay, an 8 amp fuel pump relay and a voltage supply for the injectors in one convenient package. Euro style connectors make creating a wiring harness a snap. The TEC-II is designed to be placed into the engine compartment making it unnecessary to bring wiring harnesses through the fire wall. The following is a list of popular configurations, however many custom configurations for example one and two cylinder units can be special ordered.

TEC-II 4 cylinder

This is one of the most popular configurations, it is used on any even fire four cylinder four stroke engine, and will also work on even fire two cylinder two strokes.

TEC-II 4 cylinder dual plug, single and dual sensor

The dual plug 4 cylinder TEC II is configured for up to 8 injectors, and with the dual sensor unit two crank sensors are used allowing for timing split between the intake and exhaust (leading and trailing on rotaries) spark plugs. The dual sensor units also utilize staged injector operation to accommodate secondary injectors on the rotary engines.

TEC-II 6 cylinder

This configuration is used on even fire six cylinder four stroke engines, as well as both two and four stroke three cylinders.

TEC-II 8 cylinder

The TEC II eight cylinder allows for easy fuel injection conversion on many projects, and since all Total Engine Control systems include an advanced distributorless ignition system, it has become a popular item on hot rod V-8 engines, where space in the engine compartment is limited. This unit has also been used on four cylinder engines running in RPM ranges higher than 12,000. By moving the crank sensor to the camshaft of a four cylinder engine the TEC 2, 8 cylinder will make it possible to run engines on a coil per cylinder, sequential injection basis up to 24,000 RPM.

HPV- 3b

The HPV 3b is essentially a TEC 2 with its injector driver circuits omitted. These units are used to provide maximum tuneability to the spark advance in applications where fuel injection is prohibited. They will utilize all the spark control parameters of the TEC-II, and are available in the same configurations.



TEC-II 8cylinder

Software Options

Electromotive provides different calibration software packages to best suit the user's needs. All current, version "II" software includes real time readout of pulse width and duty cycle from the engine monitor screen. Upgrades are available from older software versions.

SUPER

Electromotive's base calibration software for use with TEC-I or TEC-II. Super provides the user with access to all calibration items for getting an engine running for the first time. Use this software if your TEC has a 33 series PROM. SUPER allows you to:

- Change Raw fuel and other injector parameters.
- Change General purpose parameters.
 - Change general purpose table.
 - Change general purpose PW frequency.
- Change Enrichments.
 - Change Choke enrichment parameters.
 - Change Acceleration enrichment parameters.
 - Change De-acceleration enrichment parameters.
 - Change MAT-density enrichment/enleanment parameter.
- Change Volumetric Efficiency table.
- Change Advance table.
- Change Coolant advance table.
- Change EGO parameters.
- Change Knock control parameters.
- Change Idle Speed parameters.
- Change Rev Limiter.
 - (switch activated auxiliary rev limiter available)
- Change Sensor Failure parameters.
- Disable/Enable Manifold Air Temp. sensor.

PAFZ

This software adds Proportional Air/Fuel control and Mass Air Flow (MAF) Sensor capabilities to SUPER along with faster communications rates. This truly versatile street type of software adds:

- Change EGO parameters.
 - Change air fuel ratio table.
 - Change other EGO parameters

*G

This denotes the Graphical Data Logging option for Super and Pafz software packages. These programs feature the ability to graphically monitor the engine and store the data simultaneously on your computer's disk drive. The stored data can be retrieved and viewed later. The data can also be transferred into popular spreadsheet programs for more detailed analysis. Look for these items on the first screen of your software:

- Edit an existing calibration file.
- View an existing data file.**
- Program TEC.
- Monitor Engine functions.
- Print Calibration file.
- Display files.
- DOS access.
- Data Graphics.**



*Blend

This suffix indicates the software's ability to "Blend" the low and stable Throttle Position Sensor Voltage with the high and erratic Manifold Absolute Pressure Sensor voltage usually associated with aggressively cammed engines and/or individual throttle butterflies. Available in Super*Blend or PAF*Blend versions, both include Graphics and Data Logging, however PAF*Blend does not share PAFZ's ability to use a MAF sensor. Look for this additional screen:

Change Enrichments.

Change Blend parameters.

Change Choke enrichment parameters.

Change Acceleration enrichment parameters.

Change De-acceleration enrichment parameters.

Change MAT-density enrichment/enleanment parameter.

PAF*Blend

This software allows one additional new item for adjusting timing based on manifold or ambient air temperatures. You will find the following:

Change MAT-density parameter

Density enrichment/enleanment value DEO

Density retard/advance value DRO

HPV3G

This software is only to be used with the HPV-3B Spark Ignition only system. The latest, "G" version, incorporates new help screens, as well as data logging and graphics. Use it with 22 series PROMs.

Hot Keys and Help Screens

When using the calibration software you may want to familiarize yourself with the HOT KEYS built into the software. These are 'one touch' key strokes identified by a highlighted letter in the description of the selection.

On the bottom of some of your screens in the calibration software you will find a control bar with other 'quick keys' such as 'CTRL + P = Toggle COM PORT' this is found at the bottom of the main page and allows you to switch between COM1 and COM2 of your computer.

Here is a list of major HOT KEYS:

F1 Help, this will display a screen describing the parameter that your cursor has currently selected.

Ctrl+P Toggle Com Port, this allows you to switch between COM 1 and COM 2 from the main page of the software.

Ctrl+Z Fast Save & Download, allows you to quickly save a calibration and download it to the TEC from the main calibration page, provided the TEC is ON.

M Monitor Engine, allows you to enter the monitor screen from the calibration page or the main page.

E Edit, this allows you to enter the main calibration parameter page directly from the main software page or the Monitor Engine page.

T Toggle Temperature, allows you to switch between °F and °C in the Monitor Engine Page, it also converts the kPa to "Hg for vacuum and pressure display.

NOTE: ALL PRESSURE VALUES ARE ABSOLUTE.

ESC Exit, allows you to leave the current screen or go back to the previous.

C Toggle EGO sensor on and off from the monitor screen.

FUEL INJECTION FUNDAMENTALS

Basic Fuel Atomization

The first Spark Ignition Engine didn't really get going until there was a way to atomize the fuel with the air going into the cylinder. Over one hundred years ago the first fuel delivery system was developed. Using a venturi in the inlet air stream to lower the air pressure, and then using this low pressure to suck fuel through a fixed orifice out of the fuel storage area ... the carburetor was born.

Once the engines ran, man has always looked for ways to make it run better, and someone realized that the engines would run best when the venturi in the carburetor was optimized in size for a certain amount of air flow, trouble was, this venturi size didn't necessarily make the engine perform at its best at lower air flow numbers. So now compromises were introduced ... not too small as to restrict top end too much and not too big as to adversely affect driveability.

If one could just do away with this venturi thing. Next idea was to force the fuel through a fixed orifice by pressurizing the fuel supply ... but how to regulate this? Along came a new set of ideas: Try varying the fuel pressure ... higher pressures would produce more fuel, problem is at low fuel pressures there would still be a little atomizing problem, but we're getting closer! Now if we position the injectors (that's right there's that word) closer to the intake valve we don't have to risk the fuel falling back out of the air on its way to the cylinders.

Now lets see if we can't optimize the atomization and still control the amount of fuel going to the cylinders. The best fuel pressure depends on the design of the orifice or injector, so once we establish the best pressure ... maybe we could turn the fuel on and off, leaving it on longer when we need more fuel. How do you do that? Enter the electromagnetic solenoid. Turn it on for 25 % of the time and you'll get 1/4 the fuel as when you turn it on for 100 % of the time. Next let us take a look at *when* to turn on and when to turn off the fuel. If the cylinder has a volume of, say 100 cc's and we want the proper amount of fuel every time, then it just makes sense to fire the injectors in sync with the engine.

Theory of Linear Thermodynamics

Unlike OEM style fuel injection control systems, Electromotive's TEC (Total Engine Control) series of Engine Management Systems approach the calibration of the fuel curves from a totally different direction. Our competitors basic approach is to select a number of points in the engines operating range, and determine by trial and error what that given points fuel requirement is. This is what people usually refer to as a Pulse-width table and the resolution often discussed is the number of different value that can be entered here. While the engine is running the computer is constantly looking up the proper pulse width based on engine load and engine RPM.

The TEC is not doing this! In Theory if a cylinder has a volume of 100 cc's and we know that it will take an injector pulse-width of let's say 8 milliseconds (ms) to add the proper amount of fuel at wide open throttle (0" of Hg or aprox. 100 kpa) than consequently at light throttle (10" of Hg or 62 kpa) the engine would only use approximately 62 % of the 8 ms. This fundamentally different approach to determining the pulse width is what Electromotive calls linear thermodynamics. This allows the processor to work with a full 256 separate load points. The 8 milliseconds discussed in this example would be the Time On for Gama (TOG).

Electromotive uses the following algorithm to determine the Injector's pulse width:

$$\text{PULSE WIDTH} = (\% \text{ of MAP} \times \text{TOG} \times \text{Gamma}) + \text{IOT} \pm \text{BTO}$$

% MAP is the first and foremost value for determining Pulsewidth. For a normally aspirated engine using a 1 bar MAP sensor, the range is 0 to 104.4 kpa, 0 kpa is 29.9" Hg or absolute vacuum, 100 kpa is a standard sea-level pressure or 1 bar, 104.4 kpa allows for some higher than standard pressure days. The TEC does not see these values, it only sees 0 to 5 volts and calculates the percent of range, should the engine use a 2 bar MAP sensor, the range would be 0 - 208.8 kpa (still 0 - 100% to the TEC) and consequently a 3 bar MAP would have a range of 0 - 315.5 (still only 0 - 100% of range).

TOG (Time on for One Gama) This is the base injector pulse width that all calculations are based on. TOG can be anywhere from 3-30 ms and is determined by such things as % of boost, maximum engine



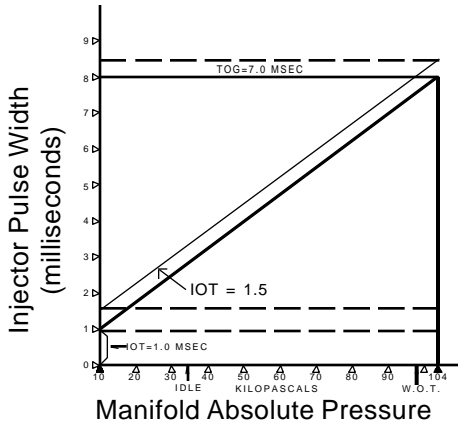

A change of .5 to IOT causes a 50% change at idle, but only a 6% change at W.O.T.

A 1.0 change in TOG has almost no effect at idle, but a 12.5% change at W.O.T.

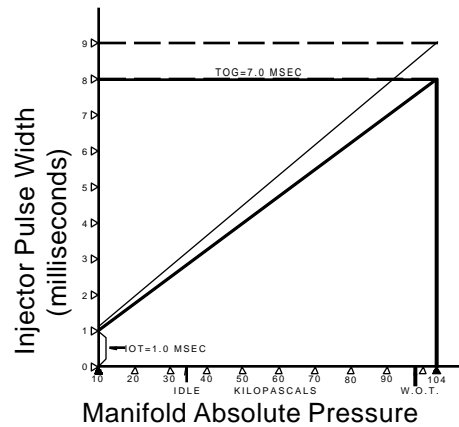

Raw Fuel Curve

RPM, Injector firing scheme and Injector Offset Time.

IOT (Injector Offset Time) is used to offset the injector pulsewidth, allowing the fuel curve to be moved by a fixed amount throughout the range. It is added or subtracted from the pulsewidth at all times. Should an engine be idling at 25% of MAP and only 25% of TOG is used, the full amount of IOT is added or subtracted from the resulting pulsewidth calculation. Regardless of any other values, IOT is always added or subtracted in its entirety from the preceding pulsewidth calculation.

Gama (Enrichments)

Gama is the total of all Enrichments added together, based on cold start, acceleration, volumetric efficiency, and all other values that are scaled in "Gama", normally Gama is 1 but when an enrichment is activated, the amount of enrichment is added to 1. For example a One Second Start Up Enrichment of 0.5 Gama would represent a +.5 in the fuel equation and Gamma would be 1.5, now assume at that temperature there is a Warm Up Enrichment of 0.25, gamma would be 1.75 and the pulsewidth would increase by a full 75% at that time.

The total enrichment value is the sum of all enrichments added to 1 and is expressed as:

$$\text{Total } G = SE + ASE + WE + AE + V/E \text{ Table} + DE + EGO + 1$$

It is this total gamma that is used in the main pulse width equation noted above. Below are explanations of each of these values. Their respective calibrations will be covered later in this manual.

Included with your software is a baseline calibration in which all of these values are preset. These preset values will allow you to get up and running with a minimum of effort.

Cold Start (SE)

Cold cranking enrichment is required to prevent the mixture from going lean due to poor fuel mixing and fall out in cold air. Much of the fuel goes to wetting the cold inner surface of the intake manifold. This additional fuel is added in for one second during cranking.

After Start (ASE)

Just after the engine starts it is necessary to keep the mixture rich for a short time to allow the idle to stabilize, light off the catalytic converter and heat the EGO sensor. The amount of cold start and after start enrichment is made a function of temperature and time.

Warm Up (WE)

Once the above two enrichments have timed out it is necessary to enrich the mixture until the engine heats up enough to correctly vaporize all its fuel. This function acts like the choke plate on a carburetor and the amount of enrichment can be varied every 10°C.

Acceleration Enrichments (AE)

When the throttle is opened momentarily, the mixture is temporarily leaned-out by the dynamics of air flow. A burst of enrichment is needed to cancel out this effect and ensure good transient response. Acceleration enrichment prevents a "flat spot" in throttle response. The amount of acceleration enrichment required at cold engine temperatures is greater than at higher temperatures, so a temperature based correction is provided. Sensitivity adjustments, constant and time based acceleration variables are also available in the TEC software.

Volumetric Efficiency (V/E Table)

This is the difference between the calculated amount of air and the actual air volume. Most Engines are not perfectly linear, dependant on Cam, Intake Manifold and other mechanical variations the engine will actually fill the cylinders with less, and on high performance vehicles, it will fill the cylinders with more than a complete charge of air ... hence the term 'Volumetric Efficiency'. At certain Engine RPMs the engine will need a little less/or a little more Fuel, in order to compensate at these points the V/E Table will allow you to add or subtract up to .50 Gama.

Density Enrichment (DE)

As previously stated, the temperature of the air in the manifold changes the charge density of the engine. The Manifold Air Temperature (MAT) sensor measures this and provides the system with a signal proportional to air temperature. An enrichment is computed to compensate for this effect.

Oxygen or Lambda Feedback Correction Enrichment (EGO)

An exhaust gas oxygen sensor (EGO) can be used to supply the electronics with information regarding whether the engine is running rich or lean compared to a user programmed switch point. Using a target of a 14.64:1 air/fuel ratio, catalytic convertors will work at peak efficiency and emissions will be minimized. This is also the point at which an oxygen sensor works with the most accuracy. The advanced EGO features available with the TEC make tuning emission legal engines easier than any other system.

Using the Proportional Air/Fuel (PAF, PAFZ) calibration software, different switch points may be entered for different operating ranges. This allows the tuner to enter leaner mixtures for low power, steady running conditions, and richer target values for higher power running. Using these self-tuning features of the TEC allows the user to get up and running much quicker than with other systems.

Total Enrichments (Gama)

All of the enrichment values noted above are summed (added) together to obtain the total enrichment (Gama). As described in the more detailed calibration section of the manual, some of the enrichments are time based, some vary with engine coolant temperature, others change as events occur, such as acceleration or EGO control. Although called enrichments, they may go in either a positive (richer) or negative (leaner) direction.

Direct Ignition System (DIS)

The Electromotive Direct Fire Ignition fires the plugs straight from the coil instead of through the cap and rotor of a distributor. This is accomplished by using twin tower coils that simultaneously fire two plugs. One plug is on the compression stroke and the other plug is on the exhaust stroke, where resistance to firing the plug is virtually nonexistent, leaving full spark energy to the compressed cylinder, where the high output is needed. The plugs are in series and use the cylinder head to complete the circuit. This requires one coil for every two cylinders in the engine: 4 coils for 8 cylinder engines, 3 coils for 6 cylinder engines and 2 coils for 4 cylinder engines. The result is an ignition system with very high energy that burns the air/fuel mixture better than other ignitions.



The TEC-II combines the coils and computer into one package. The TEC-I, available for eight cylinder racing engines, dual plug six cylinder and twelve cylinder engines, uses separate Direct Fire Units (DFU) with the coils mounted on their own chassis and wired to the TEC-I computer with a special cable.

The TEC unit computes the dwell angle, the firing time and the crank angle at which the coil is cut on for each coil. A signal proportional to coil current is sent back to the TEC controller from the coil, and is used to adjust the coil charge point so it always has time to charge the coils to the set break amps. This insures maximum spark power at all times. Full Coil charging is achieved all the way to 9,600 RPM from a 12 volt battery alone, at 14 volts (charging system active) this is 12,000 RPM.

The TEC utilizes a proprietary HREIC (High Resolution Electronic Ignition Chip) integrated circuit. This digital chip is a custom CMOS chip that performs all of the ignition computing functions, removing a great deal of the computational overhead from the microprocessor.

A 60 minus 2 tooth trigger wheel on the crank supplies the TEC with engine speed and position data. Two teeth have been removed for synchronization purposes. A single magnetic (reluctance) sensor is toggled by the protruding teeth of the trigger wheel. The HREIC chip determines when the two missing teeth pass the sensor and synchronizes the TEC to the crank without any chance of misfiring a coil. The minimum crank speed for synch to occur is 40 RPM and the maximum engine speed is over 13,000 RPM.

Trigger wheel diameters of 2½, 3½, 5, 6, 7¼ and 8¼ inches are available. All are 1/8" thick. It is vital the crank trigger wheel be mounted so the run-out is less than 0.003 inches. This task requires good machinist skills and extreme care. The magnetic sensor is 3/8 inches in diameter and 1 inch long with an attached cable. The sensor must be mounted in an aluminum bracket that is strong enough not to vibrate. The bracket is best attached directly to the engine block.

A camshaft (distributor) trigger is also available. Although sometimes easier to install, it is less accurate due to backlash and play in the drive mechanism. A 120 tooth wheel, with two pairs of teeth missing 180 degrees apart, is used with a half-engine speed drive, THESE ARE CAPABLE OF UP TO 5500 RPM ON 2.75" AND 7500 RPM ON 3.25", BUT NOT RECOMMENDED FOR OTHER THAN MILD PERFORMANCE APPLICATIONS.

Three Dimensional Spark Advance Table

TEC has a three dimensional spark advance table that allows the advance to be mapped over the entire engine operating range. Sixty-four (64) values can be entered and a straight line interpolation is made by the computer between these programmable points, both in the RPM and MAP (load) axis. The spark advance in TEC can be set from 0 to 60 crankshaft degrees BTDC. The system computes advance with a resolution of 1/4 degree and as a result, the spark scatter (jitter) is practically nil. Spark jitter is the fluctuation of the spark firing from the desired amount and can be confirmed by observing a timing light on the degree marker of a running engine.

Three dimensional spark mapping is vital to correctly tune an engine over its entire operating range. Incorrect timing causes excess heat in the exhaust (retarded timing) and destructive detonation (over advanced). Low engine speeds should have smooth curves to prevent surges caused by large advance angle changes for small changes in MAP or RPM. EITHER EXTREME OF IGNITION TIMING CAN CAUSE ENGINE DAMAGE. Timing advance curves should be set very carefully and conservatively so as to avoid engine damage.

The TEC also has a single page coolant temperature advance table that allows the advance to be increased for lower engine temperatures. This corrects for the slower burning, richer cold air-fuel mixture. This parameter has twelve fixed coolant temperatures from -30 Degrees C to 80 Degrees C.

Two other systems contribute to spark timing control. Spark controlled idle speed increases the timing if the engine is running too slow and decreases it if it's going too fast. Knock control retards the timing when engine knock occurs.

Initial advance is also programmable. This value is the advance the engine gets just after starting and before the first RPM column in the advance table is reached.

PRE-INSTALLATION CHECK LIST

To perform a complete TEC installation the following items are required:

1. TEC Computer Controller
2. Direct Fire Unit (TEC-I ONLY)
3. Magnetic sensor
4. Crankshaft or camshaft pickup wheel or drop-in trigger assembly
5. Coolant Temperature Sensor and Cable (CLT)
6. Manifold Pressure (MAP) or a Mass Air Flow (MAF) Sensor
7. Throttle Position Sensor (TPS)
8. Power Relays (30 amp)
9. Serial Computer Hookup Cable
10. Fuel Injectors (see section on how to size injectors)
11. Manifold Air Temperature Sensor and Cable (MAT)
12. Fuel Rail(s) and pressure regulator
13. Exhaust Gas Oxygen Sensor (EGO)
14. Idle Air Speed Motor (IAC) and body (Optional)
15. Knock Sensor (Optional)
16. Electric Fuel Pump
17. Resistor type radio suppression spark plug wires with GM late model ends.
18. IBM PC type computer, at least 512K memory, DOS 2.0 or higher and a serial port
19. Fuel Injector Connectors or wiring harness assembly
20. 12 and 16 ga. automotive hookup wire, crimper, Faston connectors, assorted wiring hardware
21. 1/4" dia bolts at least 1" long

The installation of a complete TEC system requires installing the TEC computer and ignition, sensors and relays, a crankshaft trigger wheel, fuel injectors with fuel pump and regulator and then hooking up all the cables. Mounting locations must be found for TEC, or the TEC computer and Direct Fire Ignition Unit on the TEC-I. Additionally, other smaller parts must have mounting locations if the engine does not already have these parts. Start with the TEC; refer to the System Diagram in the figures section to see how the parts fit together.

TEC Installation

Install the TEC where temperatures stay under 200° Fahrenheit and are out of direct water contact. Keep the length of the spark plug wires in mind when selecting a suitable location. Fenders, firewalls and intake manifolds are generally acceptable. Consider the servicability of Sensors and their wires, as well as the communication wires. Fasten the TEC securely with 1/4" bolts. It is usually not necessary to shock mount the TEC, but don't bend the control unit by overtourqueing the Chassis to an uneven surface. If the TEC is bolted to rubber pads, make sure to ground the body of the TEC. It is always good practice to ground the control unit both to the chassis of the vehicle as well as to the engine block, this will save the control boards from burning up because the TEC was inadvertently used as a ground path.



Trigger Wheel & Sensor Installation

The 60-2 tooth trigger wheel is the foundation Electromotive's products are built on and this is where it all begins. Your primary input to the TEC or HPV is this trigger wheel, which has 60 evenly spaced teeth for acquiring the crank angle down to 1/4 degree of accuracy, two of the teeth have been removed to reference TDC cyl #1, hence the term 60 minus 2.

Crank Trigger Wheel and Sensor Installation

The trigger wheel and magnetic sensor must be installed properly since they identify the crankshaft position down to the nearest 1/4 degree. There are two styles of trigger wheels available. The crankshaft wheel (60-2 tooth) is the recommended approach, as it minimizes spark scatter from gear lash and cam twist. This wheel has 58 teeth spaced at 6 degree intervals. The camshaft trigger wheel (120-4 tooth), designed to operate on half-speed shafts, mounts in place of the distributor rotor or on the end of a camshaft. When installing the trigger wheel, make sure that the trailing edge of the 11th tooth after the two missing teeth passes the magnetic sensor at TDC of #1 cylinder. Follow the appropriate instructions below.

Align sensor
with the trailing edge
of the 11th tooth

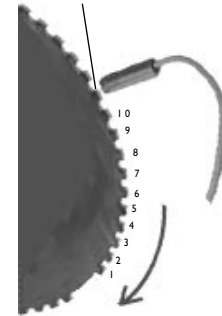

Sensor Alignment

Crankshaft Trigger Wheel

Crankshaft trigger wheels are available in 2½", 3½", 5", 6", 7¼" and 8¼" diameters; all are 0.125" thick. These wheels are typically mounted between the harmonic balancer and the first pulley. This may require the assistance of a machine shop. To choose the proper wheel size, find a suitable location on an accessible part of the crankshaft and note the diameter of the largest part of the hub, vibration damper or pulley. The trigger wheel must be spaced at least ½" away from other steel rotating parts as other steel parts will cause interference with the sensor signal.

It is important that the trigger wheel be mounted so as to be perfectly concentric with the crankshaft. One approach is to machine a shallow cut on the front or back face of the damper, and open up the hole on the inside of the trigger wheel to match, allowing the wheel to be pinned or bolted in the proper location. Holes may also be drilled through the wheel, in order for it to be mounted between the damper and pulley. Remember that placing the trigger wheel behind the pulley will space the pulley(s) out 0.125", causing a slight offset on the belt(s).

The trigger wheel should show no more than .003" out-of-round. If necessary, the entire damper/trigger wheel assembly may be put on a lathe and trued.

Trigger Wheel Size	Air Gap	Allowable Out-of-round
2½"	.009" - .010"	.001"
3½"	.011" - .012"	.001"
5"	.018" - .021"	.002"
6"	.024" - .028"	.002"
7¼"	.029" - .031"	.003"
8¼"	.035" - .038"	.003"

REDESIGNED TRIGGER WHEEL PROFILES (AS OF APRIL '99)

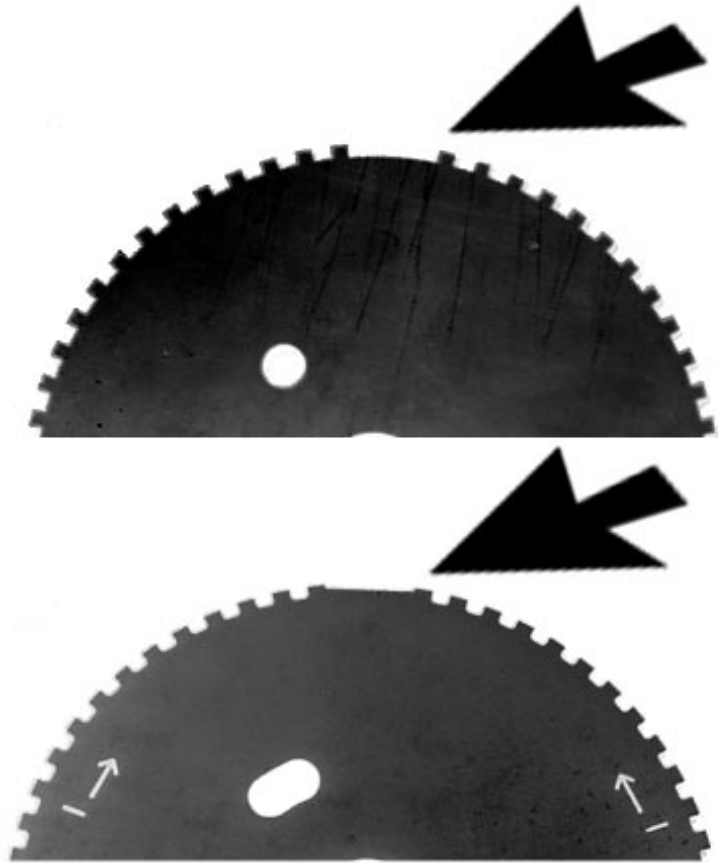

In an effort to reduce sensor failures by trigger wheel strike and/or debris getting in between the wheel and sensor, a new profile for the trigger wheel has been developed, allowing TWO to THREE times the sensor gap normally associated with trigger wheels of this size.

These Trigger Wheels should not need to be trued, because of the larger sensor gap, the allowable out of round has also increased by the same factor.

Note the difference in the missing teeth area above.

This change in trigger wheel design allows for a much larger sensor gap than previous designs, however, as sensor gap increases, the susceptibility to noise interference increases. As we learn more about this new design, we will update this section of the manual with more information.

Camshaft/Distributor Trigger Wheel

Although crankshaft mounting is preferred, it might sometimes be easier to mount the trigger wheel to the end of a cam or in the original distributor. For these applications, where the wheel will be turning at half-crankshaft speed, a 120-4 tooth wheel is provided. These may be ordered in 2¾" (good to 5000 rpm) or 3¼" (good to 7,500 rpm) diameters. Installation on the cam is similar to the procedure discussed above for crankshaft mounting. Inside the distributor, an adaptor might be made to attach the trigger wheel to the distributor shaft. Even an old rotor might serve as a starting point for such an installation.

Remember that these are general suggestions only. If you are not sure how to proceed, Electromotive can often direct you to a Value Added Dealer for assistance.

Magnetic Sensor

Test fit the trigger wheel to the crankshaft and design a sturdy aluminum bracket to hold the magnetic sensor. The tip of the sensor should align to the center of the wheel's edge. The sensor must also line up with the trailing edge of the 11th tooth after the two missing teeth when the engine is at TDC. Once the wheel is in place, accurately align the magnetic sensor to the 11th tooth with the proper air gap.

The bracket can be installed anywhere as long as the magnetic sensor aligns with the 11th tooth when the engine is at TDC. This bracket must be nonferrous (not made of steel) and should be stout enough not to vibrate.

Secure the sensor in the bracket with a clamping arrangement. Set screws often crush part of the sensor, leading to premature failures. When drilling the hole for the sensor, start with a small pilot hole. Make sure your alignment is correct before drilling the hole to final size. For the final hole, use a drill bit just under the size of the sensor (3/8" or .375"), then do a final pass with a .375" bit at slow speed to keep from having too large a hole.

Note On Hard-Starting Radical Camshaft Engines

If your engine is equipped with a radical camshaft that has early intake valve openings, long duration and high lift, you may experience hard starting. To remedy this situation, advance the base timing by substituting the 12th or 13th tooth in the above instructions. If the 12th tooth is used, you must subtract 6 degrees from your spark timing table. The 13th tooth requires 12 degrees to be subtracted from the advance curve. From the 11th tooth, every tooth represents 6 degrees.

Drop in Trigger Assemblies and other distributor replacement Assemblies



Small and Big Block Chevy



Chrysler 2.0 DOHC Trigger Assemblies

Honda TEC II Kit Installation Instructions

Before attempting to connect your new TEC II up to your engine, be sure to thoroughly review the TEC-I, TEC-II, & HPV-3b Installation and Calibration Manual so that you will have an understanding of the suggestions below. These supplemental instructions to the Installation and Calibration Manual are only written to help you install the special offer Honda TEC II Kit more easily, not for software calibration tips. Refer to the Manual sections *Working with the Calibration Software* and *Before You Start the Engine* for software information. The instructions below will specifically help to clarify how you will connect the wiring to some of the original equipment manufacturer (OEM) wiring and to the new sensors you received with your Honda TEC II Kit.

The following instructions assume that you have read through the Installation and Calibration Manual sections from *Power and Ground Connections* to *Wiring Diagrams*. From the *Wiring Diagrams* section, refer to the **TEC II, 4 & 6 Cylinder** figure. You will also want to thoroughly understand the procedure laid out under *Pre-Installation Checklist, Honda Distributor Replacement ... Installation Instructions* if you purchased a distributor trigger wheel assembly. If you are sensing the engine's speed directly off the crankshaft, be sure to carefully read the recommendations under *Trigger Wheel & Sensor Installation* (same *Wiring Diagrams* main heading). If your engine is equipped with a VTEC valve train, also refer to the **Hints and Help on Wiring Honda's VTEC** wiring diagram after the *Honda Distributor Replacement ... Installation Instructions*.

First, find a place to mount your TEC II in the engine bay (away from direct heat, near the battery and/or spark plugs, on a flat surface, etc.). Route the power wires of the TEC II (red/black out of the side) to the battery, cut them to the appropriate length, and crimp two of the ring terminals to the ends. As stated in the Manual, we do not recommend fusing either of these wires to minimize voltage drops. Next, mount the MAP sensor as close to the intake manifold as possible. Be sure to plumb the MAP sensor (3/16" vacuum hose) into the intake manifold's plenum after the throttle body, not to one of the throttle body's high vacuum ports used for emission controls. Now install the heated exhaust gas oxygen (HEGO) sensor into the collector of the exhaust manifold. Do not install the HEGO in a single runner or after the catalyst. Secure the HEGO's wire so that it will not rest against the hot exhaust system. Knowing where the magnetic sensor will be installed (camshaft or crankshaft), connect the MAP, HEGO, and magnetic sensor cables to their sensors and route them back to the TEC II following the wiring diagram given in the Manual. A suggestion for the HEGO switched +12V wire is to connect it to the fuel pump output or the switched side of the fuel pump relay. When connecting the MAP sensor cable, the red wire connects to pin 4- +5V, white to pin 3- MAP, and black to pin 2- S GND. For the magnetic sensor cable, connect the red wire to pin 7- MAG PU, black to pin 6- S GND, and the bare wire to pin 8- SHIELD. When inserting wires into the connectors of the TEC II, only strip 3/16" of insulation from the wire end, and when possible, bend the bare wire back over the insulation before inserting it into the screw terminals. This will reduce fatigue wear on the wire.

Now all that remains is to connect the TEC II to OEM wiring. When you cut into the OEM wiring harness, be sure that a connector is between the point where you're cutting and the sensor or injector (the connector may be attached directly). Never cut the wiring harness at a point such that you will have to cut it again if the engine or any part of the engine is removed from the car. When you cut into a part of the wiring harness that is attached to the vehicle's frame (such as through the firewall or to a fuse box), taking precautions about connector location is unnecessary. When using the butt connectors provided, strip the wire of its insulation only 3/16" from the end. Sometimes it is better to strip 3/8" of the insulation and double bare wire before inserting it into the butt connector (20 ga. wire only) for a better crimp. When crimping butt connectors, only crimp in one location per wire end near the center of the stripped section. Crimping twice will weaken the first location and perhaps cause premature failure.

Now, locate all of the components or wiring you will need to operate the TEC II. Some notes on where to locate these components or wiring are listed below.

Check Engine Light Wiring: This should be located under the instrument panel. Test the wiring of the Check Engine Light to locate which end is ground and which is power (make sure that the Check Engine

Light is rated for no more than 0.25 A). Confirm that the light receives continuous power with the ignition key since the TEC II will control the ground. If the light happens to be controlled by the OEM computer on the power side, measure the voltage supplied and apply an ignition switched voltage of the same rating.

Coolant Temperature Sensor: This is usually located at the engine coolant outlet under the distributor of the cylinder head. Sometimes near the same location, there is also a radiator fan thermostatic switch. Identify that you do indeed have the correct connection by measuring the resistance across the component terminals. If you are unable to measure any resistance across the terminals, you are most likely testing the thermostatic switch. If you have no thermostatic switch, you may consider putting one into your coolant system to turn on and off the radiator fan since most likely the OEM computer was controlling that before and will be disabled now with the TEC II operating the engine. The coolant sensor wiring has no particular connection orientation since the sensor is simply variable resistance, so connect the two sensor wires to pins 1 and 2 in any order. If the sensor has more than two wires, identify which two are connected to the OEM computer for engine coolant measurements and use them. Other wires could be relaying information to the instrument panel or elsewhere.

Fuel Injectors: One wire of each fuel injector should be a common color. Trace these wires back until they fuse into one or are side by side in the wiring harness. Connect these wires to the kit included red wire that splits into four smaller wires. Route this back to the TEC II +12V injector common (14- INJ COM) or to the output of the fuel pump relay (recommendations given in the Installation and Calibration Manual). Given that the typical firing order is 1-3-4-2, connect the remaining wire of cylinder #1 and #4 injectors to pin 11- INJ1 using the white wire, while cylinder #2 and #3 injectors should connect to the blue wire going back to pin 13- INJ3 (pin 12- INJ2 is not used on a 4 cylinder TEC II).

Fuel Pump Wiring: It is recommended that you follow the instructions described in the Installation and Calibration Manual for using an external fuel pump relay. You can typically find the fuel pump power wire under the instrument panel, drivers side exiting the OEM computer relay. Trace the wire from the fuel pump back if you're not sure where to locate it otherwise.

Manifold Air Temperature Sensor: This is located in the common area of the intake manifold. The sensor wires have no particular connection orientation, as with the coolant sensor, since the sensor is a variable resistance measurement. Connect the two wires to pins 11 and 12.

Switched Battery Wiring: Look first under the engine bay's fuse box, then under the instrument panel only if necessary. A good wire to find is the alternator's +12V field voltage wire. It is very important to understand that the switched battery wire needs to have a +12V reference when the key is turned to the RUN/ON and START positions, otherwise the TEC II will not be on while you're trying to start the engine, but make sure the +12V falls to 0V when the key is OFF.

Tachometer Wiring: If you are using an aftermarket tachometer, you only need to reroute the input wire to the TEC II. If you are using the OEM tach, find the input wire under the instrument panel and route that to the TEC II.

Throttle Position Sensor: Located at an end of the throttle blade shaft, this sensor has three wires which you will need to connect to the TEC II such that the voltage increases as the throttle opens. To locate which wires connect to the TEC II, measure the resistance between the wires of the sensor. Find the two wires with the greatest resistance. The remaining wire attach to the blue wire (5- TPS). Measure the resistance now between the blue wire and the others. Attach the wire which gives the greatest resistance to the red wire (4- +5V), and attach the wire with the least resistance to the black wire (6- S GND).

VTEC Solenoids (Fig.1): Typically, VTEC solenoids are grounded through the engine block and require +12V to activate the single wire coming out of the solenoid. Use the wiring

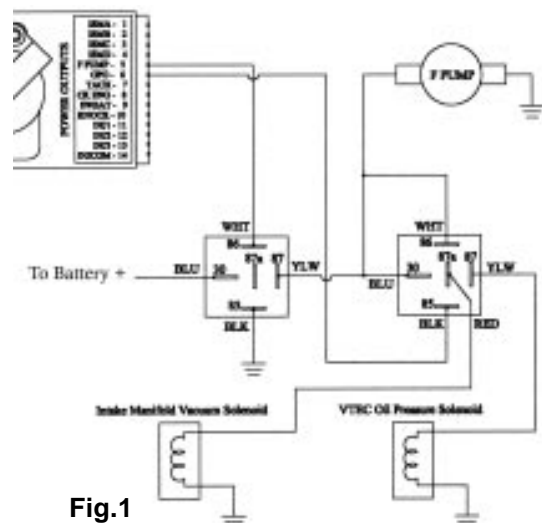

Fig.1

diagram in the [Installation and Calibration Manual](#) as a reference for connecting the solenoid wiring to the TEC II. If the solenoid has two wires attached as found with the 1.8L VTEC intake manifold vacuum solenoid, either +12V can be used to actuate the solenoid using a relay as soon in the [Installation and Calibration Manual](#) wiring diagram or the GPO ground can be used directly as long as the solenoid has more than 36 ohms of resistance.

If you have purchased the optional GM o-ring style Idle Air Control (IAC) motor, also referred to as an Idle Speed Motor (ISM), with the universal barbed housing, connect the wires to the TEC II as follows:

Red: pin 1- ISMA

Black: pin 2- ISMB

Green: pin 3- ISMC

White: pin 4- ISMD

Finally, cut off the communication cable's insulated female spade connectors, strip the wires, and connect the red wire to pin 14- RXD, the white wire to pin 13- TXD, and the black wire to pin 12- GND. Your TEC II should be ready to connect up to a PC using the calibration software now and verify the wiring on the Monitor Engine screen. Look for any sensor failures in the lower right box and for any intermittent failures at the top of the screen. If any sensors have failed, download a program to clear all stored failures, then recheck your wiring with the TEC II off. If some sensors are disabled (such as the MAT) that you wish to use and are wired, change the calibration program parameters to make them active and download the new program.

You will need to replace your distributor style, spark plug wires with direct fire types before attempting to run your engine. Electromotive has contacted several wire manufacturers to notify them of your custom needs. Follow the recommendations given in the *Spark Plugs and Spark Plug Wires* section of the [Installation and Calibration Manual](#) for size and construction. With your trigger wheel installed, your spark plug wires attached, and an initial calibration program adjusted for your engine, you should be ready to begin tuning your new TEC II for maximum performance.

Neon TEC II Kit Installation Instructions

Before attempting to connect your new TEC II up to your engine, be sure to thoroughly review the [TEC-I, TEC-II, & HPV-3b Installation and Calibration Manual](#) so that you will have an understanding of the suggestions below. These supplemental instructions to the [Installation and Calibration Manual](#) are only written to help you install the special offer Neon TEC II Kit more easily into your vehicle, not for software calibration tips. Refer to the manual sections *Working with the Calibration Software* and *Before You Start the Engine* for information pertaining to the software. The instructions below will specifically help to clarify how you will connect the wiring to some of the original equipment manufacturer (OEM) wiring and to the new sensors you received with your Neon TEC II Kit.

The following instructions assume that you have read through the [Manual](#) sections from *Power and Ground Connections* to *Output Devices*. For Neon specific wiring diagrams of the TEC II, refer to the **Neon TPK Wiring Diagram** and the **TEC-II Neon Wiring Diagram** figures at the end of these instructions. Installation of the camshaft or crankshaft trigger assemblies is covered after the wiring instructions you find below with some helpful drawing references at the end as well.

First, find an appropriate place to mount your TEC II in the engine bay (away from heat sources, near the battery and/or spark plugs, on a flat surface, etc.). We have had success mounting it exactly where the OEM computer was or on top of it if you would like to leave it in. Route the power wires of the TEC II (red/black out of the side) to the battery, cut them to the appropriate length, and crimp two of the ring terminals to the ends. As stated in the [Installation and Calibration Manual](#), we do not recommend fusing either of these wires to minimize voltage drops. Now install the heated exhaust gas oxygen (HEGO) sensor

into the collector of the exhaust manifold. Do not install the HEGO in a single runner or after the catalyst. Secure the HEGO's wire so that it will not rest against the hot exhaust system. If you are using the stock exhaust manifold and air filter box, you will probably need to remove the air filter box to get access to the sensor. Having an oxygen sensor socket handy will make things much easier (18 mm deep well socket with a slot cut into one side for the wires to exit). Disconnect the OEM MAP sensor from the stock wiring harness and connect the TEC II MAP sensor cable. Disconnect the stock wiring harness from the fuel injectors and connect the TEC II wiring cable to them. Knowing where the magnetic sensor will be installed (camshaft or crankshaft), route the MAP, HEGO, fuel injector, and magnetic sensor cables back to the TEC II and connect them to their 14 pin connectors as shown in the wiring diagrams. Another suggestion for the HEGO switched +12V wiring different from the diagrams is to connect it to the fuel pump output or the switched side of the fuel pump relay. When inserting wires into the connectors of the TEC II, only strip 3/16" of insulation from the wire end, and when possible, bend the bare wire back over the insulation before inserting it into the screw terminals. This will reduce fatigue wear on the wire.

The MAT sensor should be installed next, however, this sensor can be disabled temporarily in the software to get you up and running sooner. The MAT sensor requires a 3/8" NPT threaded hole and ideally should be located in the intake manifold's common area. But for convenience, it could be located in some part of the intake air stream before the throttle body. If you are using any type of forced induction (turbo-charger, supercharger, nitrous, intercooling, etc.), be sure that the MAT sensor is after these modifications since the charge temperature will be affected. Route the MAT sensor wires to the TEC II when it has been installed. Connect the gray wire to pin 11- MAT and the black wire to pin 12- GND. If the wires happen to get switched, there will be no failure because the sensor is only a variable resistance.

Now all that remains is to connect the TEC II to OEM wiring. When you cut the OEM wiring harness, be sure that a connector is between the point where you're cutting and the sensor (the connector may be attached directly). Never cut the wiring harness at a point such that you will have to cut it again if the engine or any part of the engine is removed from the car. When you cut into a part of the wiring harness that is attached to the vehicle's frame (such as through the firewall or to a fuse box), taking precautions about connector location is unnecessary. When using the butt connectors provided, strip the wire of its insulation only 3/16" from the end. Sometimes it is better to strip 3/8" of the insulation and double the bare wire before inserting it into the butt connector (20 ga. wire only) for a better crimp. When crimping butt connectors, only crimp in one location per wire end near the center of the stripped section. Crimping twice will weaken the first location and perhaps cause premature failure.

Now, locate all of the components or wiring you will need to operate the TEC II. Some notes on where to locate these components or wiring are listed below.

Check Engine Light Wiring:

This wire can be tapped into either out of the OEM computer or under the instrument panel. For most model years, the OEM Check Engine Light wire will be black/pink all the way from the OEM computer to the instrument panel. The black/pink wire should exit the OEM computer connectors at pin terminal 8.

Coolant Temperature Sensor:

Located in the intake manifold's thermostat housing of the DOHC engine or next to the camshaft position sensor on the driver's side of the SOHC engine, the coolant sensor typically has three wires. If it only has two, connect these to the TEC II at pin 1- CLT and pin 2- S GND; the sensor is a variable resistance like the MAT so either wire can connect to either pin without a failure. If the sensor is a typical three wire, combination sensor, one wire (violet/yellow) provides a signal for the instrument panel's temperature gauge. The other two wires (usually black/light blue and tan/dark blue for the SOHC, black/red and tan/black for the DOHC) need to be connected to the TEC II at pins 1 and 2, again which wire is connected to which pin does not matter. If your sensor does not follow this color convention, trace the wires back to their origins or find a wiring diagram for your car's model year. If you would like to use the OEM wire routing, look for the sensor wires in the OEM computer connectors at pin terminals 26 and 43, checking

continuity to the sensor connector terminals to be sure.

Fuel Pump Relay Wiring:

Follow the **Neon TPK Wiring Diagram** for connecting the fuel pump and auto shutdown relay connectors into the fuse box/power distribution center.

Idle Air Control Motor Wiring:

Use the information given in the **Neon TPK Wiring Diagram** and the Installation and Calibration Manual under the section *Output Devices* for wiring of the Idle Air Control (IAC) motor. Be especially careful wiring the IAC motor, some incorrect wiring configurations can damage the TEC II's IAC control circuits. A simple check is to measure the resistance between the ISMA and ISMB **or** the ISMC and ISMD connections of the TEC II. The resistance in this circuit should be approximately 50 ohms. If you are connected incorrectly, you will get an overload reading (open circuit). Be sure that the wires are disconnected from the TEC II while you are measuring the circuits.

Ignition Coil Pack Wiring:

Follow the **Neon TPK Wiring Diagram** for connecting the TEC II to the OEM ignition coil pack. If the wire colors do not match what is shown in the diagram, just be sure to connect the TEC II's red wire to the middle wire, the TEC II's yellow wire to the wire on the side of the 1/4 cylinder coil (usually toward the firewall), and the TEC II's blue wire to the wire on the side of the 2/3 cylinder coil (usually toward the front of the vehicle).

Switched Battery Wiring:

Remove the engine bay's fuse box only enough to turn it upside down. It is very important to understand that the switched battery wire needs to have a +12V reference when the key is turned to the RUN/ON **and** START positions (starter motor cranking), otherwise the TEC II will not be on while you're trying to start the engine. Typically, a dark green/white wire is the one you are looking for near the center of the fuse box. Test the wire for +12V while in the RUN/ON and START positions as described before. If this dark green/white wire cannot be located, find another using the conditions described, just be sure that the +12V is not present when the ignition switch is OFF (you will only be able to stop the engine then by disconnecting the Power Output connector on the TEC II).

Tachometer Wiring:

If you are using an aftermarket tachometer, you only need to reroute the input wire to the TEC II. If you are using the OEM tach, find the input wire under the instrument panel (typically gray/light blue) or at the OEM computer connector (pin terminal 73) and route that to the TEC II.

Throttle Position Sensor:

Located at an end of the throttle blade shaft, this sensor has three wires which you will need to connect to the TEC II such that the voltage increases as the throttle opens. To locate which wires connect to the TEC II, measure the resistance between the wires of the sensor. Find the two wires with the greatest resistance. The remaining wire attach to the blue wire (5- TPS). Measure the resistance now between the blue wire and the others. Attach the wire which gives the greatest resistance to the red wire (4- +5V), and attach the wire with the least resistance to the black wire (6- S GND). Typically, the black/light blue wire is the signal ground which will attach to 6- S GND, the orange/dark blue wire is the reference voltage which connects to 4- +5V, and the violet/white is the signal wire which goes to 5- TPS.

Finally, cut off the communication cable's insulated female spade connectors, strip the wires, and connect the red wire to pin 14- RXD, the white wire to pin 13- TXD, and the black wire to pin 12- GND. Your TEC II should be ready to connect up to a PC using the calibration software now and verify the wiring on the Monitor Engine screen. Look for any sensor failures in the lower right box and for any intermittent failures at the top of the screen. If any sensors have failed, download a program to clear all stored failures, then

recheck your wiring with the TEC II off. If some sensors are disabled (such as the MAT) that you wish to use and are wired, change the calibration program parameters to make them active and download the new program.

Tips in Removing the Neon's Stock Engine Management Computer

Up to this point, the engine control has now been entirely turned over to the TEC II, but some of the vehicle systems control is still being handled by the OEM computer. On the next page, we cover some of the more critical systems and some which are generally desired to keep working even though you want to take out the OEM computer. Hopefully, we'll cover as many as possible.

For those interested in completely removing the Neon's stock computer, here is a description of how to keep the alternator working (the alternator's field excitation voltage is normally controlled by the stock computer which you want to remove). An external voltage regulator for the alternator is available through any Chrysler dealer and most auto parts distributors. The Chrysler P/N is 4379100 while the standard and SAE P/N is VR-125. The regulator is an original equipment replacement for a 1986 Dodge Omni 2.2L, which may help in ordering from some dealers and distributors.

To use the external regulator on your Neon, first you must ground the case of the regulator to the vehicle chassis. Simply using sheet metal screws into the firewall will accomplish this (be sure metal to metal contact is made, paint is an insulator). The voltage regulator must be connected to the alternator and battery next. Looking at the regulator connector, the wire in the center location is the battery voltage reference. This wire needs to be connected to the switched +12V side of the Auto Shutdown relay, the yellow wire shown in the Neon TPK Wiring Diagram. This wire needs to also extend to the alternator and connect to the uppermost terminal as the alternator is oriented in the vehicle (left terminal of the connector when plugged into the alternator with the clip at the top). The other terminal on the alternator connector needs to be connected directly to and only to the remaining wire on the external voltage regulator. This serves as the field regulating voltage. Connected this way, the alternator should perform normally.

Reviewing instrument panel operations not controlled by the TEC II, the vehicle speed sensor signal and fuel level sensor signal wires typically split and are sent to both the computer and instrument panel. You will have to make sure these wires keep a continuous path from their sensors to the IP. Generally, the fuel wire is dark blue (terminal 23- OEM computer) and the vehicle speed wire is white/orange (terminal 66- OEM computer). Additionally, the stock coolant temperature sensor wire is required of the instrument panel, although its violet/yellow wire is not routed to the engine management computer, only to the instrument panel.

The OEM computer also controls the radiator fan relay. If the OEM computer is removed, use a thermostatic switch in the coolant lines. A good switch to choose for this engine would typically close at 100°C (212°F) and reopen at 94°C (201°F). The OEM computer normally controls the radiator fan relay's coil ground side. You may find this wire at pin terminal 18 of the OEM computer (light green wire) or under the engine bay fuse box with either a dark green wire or a dark blue/pink wire. Measure both sides of the radiator fan relay's coil connections in the top side of the fuse box. One should measure +12V with the battery connected, the other a floating voltage (no continuity). Test continuity of this relay connection with the wire you believe is the OEM's radiator fan relay control. With continuity confirmed, wire this to one side of the thermostatic switch you've installed into the engine's coolant with the other side of the switch connected to ground.

If your Neon came equipped with cruise control and you would still like to retain its function, unfortunately there is some bad news. The OEM computer is dedicated to managing the cruise control vacuum servo circuit, so if the computer is disconnected or turns off, the cruise control will be disabled. The OEM computer is capable of turning itself off due to a lack of appropriate signal inputs, so it is suggested that the cruise control function of the OEM computer not be used even if it is left connected to the OEM wiring harness.

** These connections can also be made to simply bypass the stock computer if it tends to turn

itself off from time to time because of a lack of appropriate signal inputs.

Installing the DOHC Only *Camshaft* Trigger Wheel Bolt-on Kit

When installing the camshaft trigger wheel, this step should be performed after all of the wiring has been checked and your ready to start the engine otherwise. When using the camshaft trigger wheel, it is also important that the engine's timing belt is in very good condition. Test fit the camshaft trigger wheel assembly before applying RTV and starting the engine to be sure that the installation procedure is well understood.

1. Remove the camshaft position sensor from the end of the intake camshaft on the driver's side. Remove the target magnet and bolt now exposed at the end of the camshaft. Clean the cylinder head o-ring mating surface of any residual oil.

2. Temporarily bolt the new camshaft trigger wheel shaft seal housing onto the cylinder head with the magnetic sensor bracket toward the front of the car. Install the chisel point magnetic sensor to verify that the wiring to the TEC II is not too short. Remove the seal housing from the cylinder head and insert the new trigger wheel shaft into the camshaft recess, aligning the locating pin with one of the holes formerly used by the OEM target magnet.

3. Without the trigger wheel on the shaft, apply a light coat of high temperature RTV sealant to the seal housing on the side of the cylinder head. Checking that some grease is in the oil seal groove, slide the housing over the trigger wheel shaft with the magnetic sensor bracket toward the front of the vehicle as described before. Screw in the bolts (with washers) to hold the seal housing firmly, but it should be able to rotate with some applied force. The bolts should be near the center of the housing slots for now.

4. With the magnetic sensor removed, install the trigger wheel onto the end of the shaft with your hand being very careful to line up the spring pin and center holes. Bolt on the trigger wheel with the extra long cap screw bolt and oversized washer, checking that the wheel is seated flat on the shaft and that the shaft is seated squarely on the camshaft. This may be tested by turning the engine over with the starter and observing if the wheel runs true, without the magnetic sensor installed. Be sure that the TEC II is completely unplugged when turning over the engine.

5. Remove the inspection access cover on the timing belt cover and clearly mark the timing marks on the camshaft gears. To find the timing marks, turn the crankshaft over by hand or use the engine starter motor. One may also put a manual transmission in first gear and rock the car back and forth until they are visible. Align the timing marks as closely as possible and install the magnetic sensor into the seal housing at an approximate 0.015" gap to the trigger wheel. Be sure that the mark on the sensor lines up with the slot cut in the bracket so that the chisel point is perpendicular to the trigger wheel teeth. Counting clockwise (looking from the driver's side) from the two missing teeth nearest the magnetic sensor (the bottom gap), rotate the housing until the sensor point aligns with the trailing edge (most clockwise) of the 11th tooth.

6. Recheck that the housing bolts are snug. Start the engine with communications established between a PC and the TEC II on the Monitor Engine screen. Press 1 on the keyboard to set zero ignition advance. With a timing light connected to cylinder #1, rotate the seal housing until the timing marks on the camshafts line up to your satisfaction. Turn off the engine and tighten the housing bolts. Recheck the timing if desired, making sure to reestablish communications and setting the ignition advance to zero. Replace the timing belt inspection cover.

Installing the DOHC Optional, SOHC Included *Crankshaft* Trigger Wheel Bolt-on Kit

The Neon Crankshaft Trigger Wheel Bolt-on Kit is designed especially for very high performance engines requiring very accurate, high energy ignition timing. It only differs from the DOHC camshaft trigger assembly by its location, directly on the crankshaft, not in any of its design purpose or operation. However, this location of the high resolution trigger wheel assembly benefits very high performance engines by not including in the sensor signal any backlash or oscillations between the crankshaft and camshafts due to the indirect drive of the timing belt. An included benefit of this trigger assembly is the reduced horsepower

losses of the power steering pump by using an underdrive pulley. Due to the position of the camshaft position sensor on the cylinder head in the SOHC engine (close to wiring and heater hose routing), the Crankshaft Trigger Wheel Bolt-on Kit is required to use a Neon TEC II computer on the SOHC engine.

1. Remove the front passenger wheel and the plastic accessory belt cover behind the wheel. Note the accessory belts tension in order to correctly set the new belts' tension. Remove the accessory belts by loosening the two adjustment nuts on the power steering pump then the one adjustment nut on the alternator along with its adjustment bolt (both alternator parts shown in figure). Remove the inspection access cover of the timing belt cover and bring the engine to TDC of cylinder #1 by aligning the camshaft gear marks. Remove the crankshaft pulley bolt (impact air hammer recommended) and the pulley using a three finger gear puller.

2. Remove the two alternator pivot bracket bolts and install the Electromotive supplied magnetic sensor bracket using the two new bolts supplied in the kit (the original bolts are too short to reinstall). Remove the three bolts and lock washers from the Unorthodox Racing underdrive pulley. Using those lock washers along with the offset spacers, longer bolts, and flat washers, bolt the 60 (-2) tooth wheel onto the underdrive pulley. Use the centering piece included with the kit to center the trigger wheel onto the pulley while tightening the bolts in the center of the trigger wheel slots; remove the centering piece. Identify the trailing edge of the 11th tooth after the two missing teeth (count counterclockwise and refer to figure) and mark the wheel at this location by scratching the surface, permanent magic marker, or otherwise. Install the magnetic sensor in its bracket with plenty of clearance between its tip and the trigger wheel (used only to reference the 11th tooth position when installing the pulley).

3. Follow the Unorthodox Racing installation instructions to heat the underdrive pulley (with the trigger wheel attached) at 350°F for 20 minutes. When installing the hot underdrive pulley/trigger wheel assembly onto the crankshaft snout, pay careful attention to position the 11th tooth (previously marked) as close as possible to the magnetic sensor tip. Following the Unorthodox Racing instructions, tighten the crankshaft pulley bolt to 30 ft-lb while hot to seat the pulley on the crankshaft snout fully. Allow the pulley to cool for at least 15 minutes then tighten the crankshaft bolt to 105 ft-lb. Examine the position of the magnetic sensor tip to make sure it is exactly in the center of the trigger wheel teeth, not to the left or right. If it is not in the center of the teeth, remove the bracket and adjust it by installing a shim or removing material. Once the magnetic sensor is aligned with the trigger wheel, set the air gap on the magnetic sensor to 0.030" with feeler gauges. Replace the accessory belts with new, shorter ones (P/N suggestions given in the figure) and retension them according to your observations at the start of this installation.

4. Now confirm the position of the 11th tooth of the trigger wheel to TDC of cylinder #1. Start the engine and set the ignition timing to zero advance by pressing 1 on the Monitor Engine screen. Use a timing light on cylinder #1 to check the alignment of the camshaft gear timing marks. If you are using a dial-in timing light, the timing advance or retard is really only half of what is displayed due to waste spark. If adjustment of the trigger wheel position is necessary, remove the crankshaft pulley bolt and temporarily install the kit's centering piece before loosening the three pulley bolts. If the trigger wheel was installed with the bolts in the center of the wheel slots, the wheel can be rotated one full tooth and a gap (6°) in either direction without having to remove the underdrive pulley. If more adjustment is necessary, repeat this installation procedure from the beginning. Once the wheel has been adjusted to your satisfaction, remember to remove the centering piece and reinstall the crankshaft bolt, torqued to 105 ft-lb. Before replacing the accessory belt cover and wheel, route the magnetic sensor cable so you can secure it to some place on the engine block as close to the sensor as possible. Repeated movement of the wire near the sensor base, even normal idling vibrations, due to not securing this wire or securing it to the frame of the vehicle will cause fatigue in the wires and sensor failure, solved only by sensor replacement. Replace the accessory belt cover, wheel, and timing belt inspection cover.

Follow the recommendations given in the *Spark Plugs and Spark Plug Wires* section of the Installation and Calibration Manual for size and construction of spark plug wires other than stock. With your trigger wheel installed, your spark plug wires attached, and an initial calibration program adjusted for your engine configuration, you should be ready to begin tuning your new TEC II for maximum performance.



Honda Trigger Assemblies

BOLT-ON TRIGGER WHEEL AND BRACKET KITS

Electromotive offers several kits for popular engines that make the installation a simple bolt-on. Below are step-by-step instructions for installation of these kits.

Small Block Chevy and Ford

Electromotive supplies bolt-on kits for Small Block Chevy and Ford engines in three configurations:

- for Chevy engines using any balancer under 7" in diameter
- for Chevy engines equipped with the GM 8", 1969 and later, high performance balancer
- for Ford 289-302 and 351C engines with the 4 bolt balancer

7" And Smaller Balancers

1. Set the engine to TDC as per manufacturer specifications and instructions. Remove the crankshaft pulley and timing tab. Clean the front of the balancer thoroughly.
2. Install the sensor bracket at the two timing cover bolts used to hold the timing tab. These are the bolt holes directly above the timing cover alignment pin on the timing tab (driver's) side of the block. The timing tab may be reinstalled with the Electromotive sensor bracket. Use the $\frac{1}{4}$ -20 X $\frac{3}{4}$ " bolts provided.
3. The $7\frac{1}{4}$ " trigger wheel mounts between the balancer and the pulley, with the "F" (at the two missing teeth) facing forward. The wheel centers itself on the pulley. If the lip of the pulley does not extend beyond the trigger wheel enough to center the pulley/trigger wheel assembly on the balancer, use the supplied aluminum stepped bushing to center the assembly. Install the trigger wheel and pulley on the crankshaft but **DO NOT TIGHTEN** at this time.
4. Install the sensor in the sensor bracket. Verify that the trailing edge of the eleventh tooth is aligned with the center of the sensor. Note that there is some adjustment provided by the holes in the trigger wheel for radial alignment. Also check that the sensor is centered above the trigger wheel in the front/back plane. If necessary, shim out the bracket with washers or lightly sand it down to move it in. Once the alignment is correct, tighten the three bolts which hold down the pulley and trigger wheel. Torque the bolts to manufacturer's specifications.
5. Set the sensor gap to .029" - .031" and tighten the sensor hold down screw.
6. Check for run-out in the trigger wheel by measuring the air gap at three points around the wheel. There should be no more than .003" variation from the smallest gap to the largest gap.

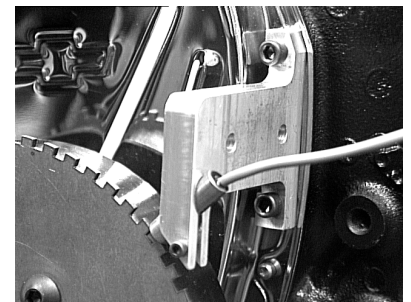

GM 8" Balancer for Small Block Chevy

1. Set the engine to TDC as per manufacturer specifications and instructions. Remove the crankshaft pulley and timing tab. Clean the front of the balancer thoroughly. Trim back the rubber separator as necessary to allow the trigger wheel to sit flush on the balancer.
2. Install the sensor bracket at the two timing cover bolts used to hold the timing tab. These are the bolt holes directly above the timing cover alignment pin on the timing tab (driver's) side of the block. The timing tab may be reinstalled with the Electromotive sensor bracket. Use the 1/4-20 X 3/4" bolts provided.
3. With the engine at TDC (top dead center), the twelve holes on the balancer resemble the numerals on a clock. With the "F" (located under the gap at the two missing teeth) facing forward, align the trigger wheel so that the holes are aligned with the holes in the balancer at the two, six and ten o'clock positions. The eleventh tooth after (counterclockwise) the missing two teeth should be aligned directly with the sensor bracket where the sensor will be. Mark the three holes and remove the trigger wheel.
4. Tap the holes to 3/8-24. Install the trigger wheel with the button-head Allen bolts provided. **DO NOT TIGHTEN** at this time.
5. Install the sensor in the sensor bracket. Verify that the trailing edge of the eleventh tooth is aligned with the center of the sensor. Note that there is some adjustment provided by the holes in the trigger wheel for radial alignment. Also check that the sensor is centered above the trigger wheel in the front/back plane. If necessary, shim out the bracket with washers or lightly sand it down to move it in. Once the alignment is correct, tighten the three button-head Allen bolts which hold down the trigger wheel. Torque the bolts to 25 ft./lbs.
6. Set the sensor gap to .035" - .038" and tighten the sensor hold down screw.
7. Check for run-out in the trigger wheel by measuring the air gap at three points around the wheel. There should be no more than .003" variation from the smallest gap to the largest gap.

Trigger Wheel And Bracket For The Volkswagen Type 1

1. Remove the crankshaft pulley. Clean the front of the engine thoroughly.
2. Locate the 6 mm Phillips head machine screw to the right of the engine seal - it holds the sheet metal to the engine block (see figure). Remove this screw and trim the sheet metal to fit the sensor bracket.
3. Install the sensor bracket using the 6 mm cap screw provided. Insert the magnetic sensor into the bracket. **DO NOT TIGHTEN EITHER AT THIS TIME.**
4. Slide the new pulley fitted with the trigger wheel onto the crankshaft in order to align the sensor and bracket assembly. Align the sensor and bracket relative to the trigger wheel. The sensor should be aligned exactly at the trailing edge of the 11th tooth after the two missing teeth. Also check that the sensor is centered over the edge of the wheel. Now remove the pulley again and tighten the bracket.
5. Install and tighten the new lower pulley and gap the magnetic sensor to between 0.011 and 0.012 inches. Tighten the set screw for the magnetic sensor. Do not overtighten - it will damage the inside of the sensor causing it to fail.



Jeep 258 cid Crank Trigger Installation

Introduced in April of '99, the 258 Crank Trigger Kit is designed to fit the 4.2 liter AMC/Jeep In-line six cylinder found in many CJ's and YJ's.

Parts List

1. 7.25" 60 minus 2 tooth Trigger Wheel
2. Aluminum Trigger Wheel Spacer Hub
3. Bolts, Washers, etc.
4. Magnetic Sensor Bracket
5. Spacers for Magnetic Sensor Bracket



Place the engine on T.D.C. of Cylinder #1
Remove the 3 bolts holding the front pulley to the balancer.

Fig.1 Remove the Bolts on the passenger side lower part of the engine block.



Fig.1

Install the Mag. Sensor Bracket, and Spacers

Fig.2 Clean the front surface of the pulley to ensure a clean fit of the Trigger Wheel Spacer Hub.



Fig.2 Viewed from Underneath

Fig.3 Using the new Bolts, install the Trigger Wheel over the hub, and with the hub in the center of the pulley onto the balancer, so that the TDC Mark appears close to the Magnetic Sensor. *Do not tighten the bolts at this time.*



Fig.3 Viewed from Underneath

Align the trigger wheel and magnetic sensor so that the trailing edge of the 11th tooth after the gap is directly under the magnetic sensor's center point.

Fig.4 Allowing .050 to .075 inches of clearance between the sensor and wheel, tighten the assembly.



Fig.4 Viewed from Underneath

NOTE:
This New Trigger Wheel Profile allows for a larger sensor gap. However, the larger the sensor gap, the more susceptible the system is to EMI/RFI noise.

General Fuel Injection Layouts

There are basically two different styles of fuel injection layouts, but all utilize an electric solenoid to control fuel flow by changing the duration of the spray.

Throttle Body Fuel Injection

TBI as it's often referred to, centralizes the injectors to an area common to more than one of the cylinders of the engine. Usually a TBI unit simply replaces a carburetor on the intake manifold and sprays the fuel right on top of the throttle plates. CFI or Central Fuel Injection is the same other than it uses high pressure injectors normally found in Multi-Point Systems.

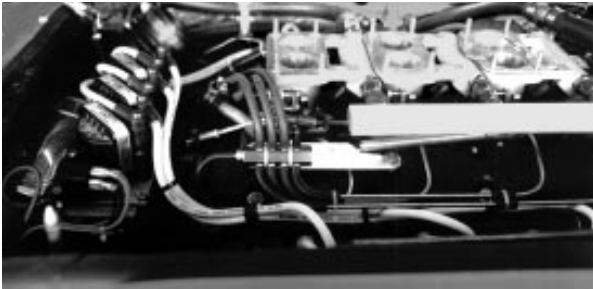
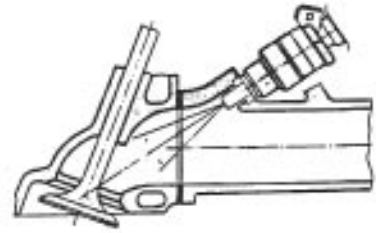

Multi-Point Fuel Injection

This is probably the most efficient type of fuel injection that is currently available, outside of some new direct combustion chamber injection. This type of injection places at least one fuel injector into each cylinder's intake runner as close to the intake valve as possible. Usually a multi-point fuel injection system has an intake plenum common to all cylinders, but an Individual Throttle Injection still utilizes the multi-point configuration, though each cylinder has its own throttle plate.

Fuel System Plumbing

When plumbing up the fuel to your fuel injection, you must take care to ensure you have enough supply as well as an adequate return to the tank from the fuel pressure regulator. Be sure your fuel pump has sufficient volume at the pressure you will be running, and when using large fuel pumps, make certain your fuel pressure regulator can return the fuel to the tank even when the injectors are turned off, otherwise Fuel Pressure will not be stable.

Check the Fuel Pressure with a 'T' somewhere between the Fuel Pump and the Fuel Pressure Regulator, if the fuel pressure drops under load, then either the pump is too small or there is a restriction.

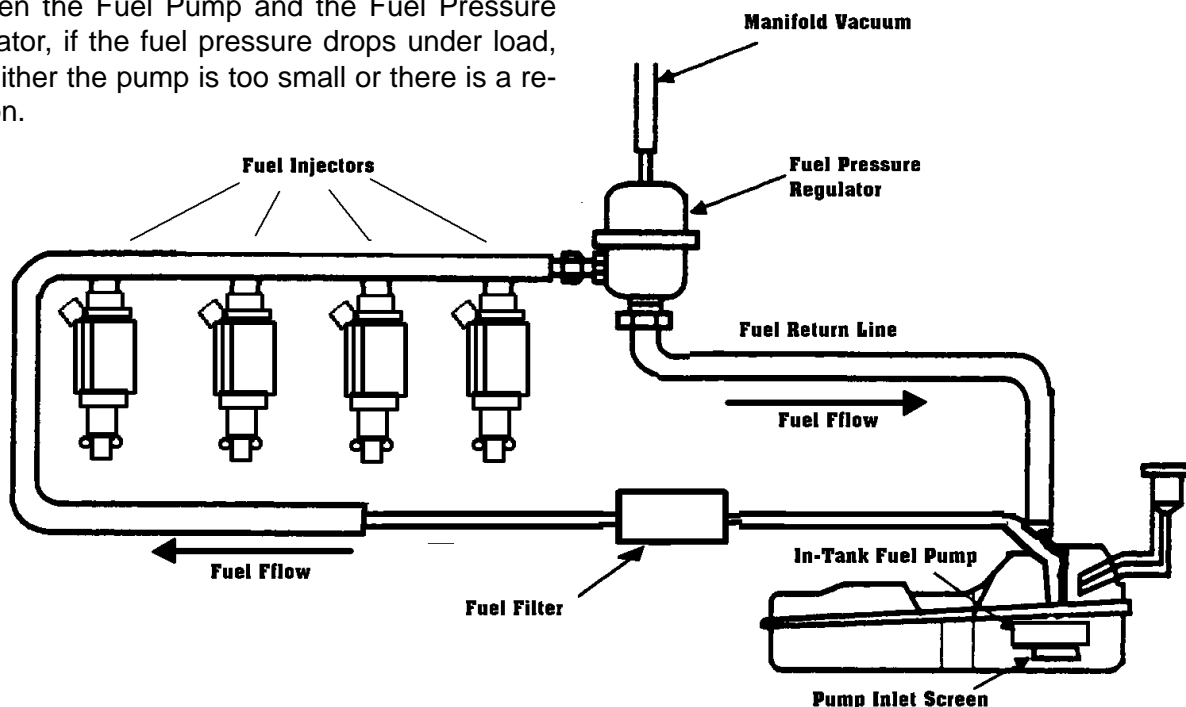

FUEL INJECTOR SELECTION AND SIZING

When sizing fuel injectors you must keep the following in mind:

1. What is the maximum amount of fuel you need to deliver? This requires knowledge of the break specific fuel consumption of your engine at maximum output, values can be from .39 (lean and efficient) to .69 (inefficient combustion chambers and lots of boost). When working with supercharged engines, remember that you need to 'feed the blower', this means that in order to make i.e. 500 HP at the flywheel, you must not forget that the supercharger may take as much as 100 HP to drive, and this power must be accounted for when figuring out your fuel requirement. Let us look at an example of how to determine the fuel requirement of an engine with the supercharger mentioned above, and a BSFC of approximately .53.

$$500 \text{ HP} + 100 \text{ HP} = 600 \text{ HP} \times .53 \text{ BSFC} = \text{Fuel requirement of } 318 \text{ lb/h}$$

2. How many fuel injectors are being used? This is pretty obvious, we need to know the per injector fuel requirement.

$$318 \text{ lb/h divided by } 8 \text{ injectors} = 39.75 \text{ lb/h per injector}$$

3. At what RPM are we making this power? This is probably where most people get stuck. Not unless you are being so crude as to run your injectors at 100 % duty cycle, can you make do with injectors sized exactly by the lb/h per injector number. A fuel injector needs a certain amount of time to recover from being engaged between spraying events. It is important to know when your injector fires for this step, but let us assume the injector fires once per engine revolution, just like ELECTROMOTIVE's phased sequential injection for multi-point systems. The engine speed for our ongoing example will be 7,600 RPM, and we need to know how much time there is between injector events.

60,000 ms (one minute) divided by 7,600 RPM= 7.8947 ms between Top Dead Centers

4. What is the % of duty cycle that can be used at this point? This is determined by the time it takes the injector to close after it has been opened, which is usually somewhere around 1 ms. Here we need to know the ratio between the total amount of time available and what we can actually use.

$$7.8947 \text{ ms} - 1 \text{ ms} = 6.8947 \text{ ms} \quad 6.8947 \text{ ms} / 7.8947 \text{ ms} = 0.8733 \text{ or } 87.33\%$$

5. Injector Size Requirement! Now we have all the info required to select an injector.

Fuel Requirement of 39.75 lb/h divided by the maximum duty cycle of 87.33% = 45.5 lb/h

With this information we can now go get an injector, and it looks like Electromotive's part # 83145, a 45 lb/h peak and hold injector will fit the bill. By raising the fuel pressure slightly over 43.5 psi to say 47 psi we should have the perfect match.



POWER AND GROUND CONNECTIONS

The Importance of the Power and Ground can not be overestimated, when installing a Total Engine Control System, make sure that there is sufficient amounts of voltage and amperage available for the system to perform at its full potential.

One of the simplest tasks turns out to be one of the most critical in wiring up a modern engine control computer. The bussing of both power and ground must be done to minimize voltage drops and signal interference from high power output devices. With ignition coils firing up to 16 amps of current and up to 16 injectors firing at 4 amps each next to sensors that are measuring millivolts, it is required to get the power and ground hooked-up so that voltage spikes are not possible.

Grounds

It is recommended to use the "star" ground approach to minimizing voltage drops caused by long leads and corroded contacts. Find a convenient bolt on the Engine block to use as a star point, clean the contact area, ground the TEC's large black wire (and in case of a TEC-I, the Direct Fire Unit's black wire as well) to this point. If a ground wire has to be extended use 12 gauge wire to do it. If the two units are mounted on the body of the car, and especially on plastic or rubber vibration mounts, add an additional ground wire between the TEC's chassis and the engine block ground. At least 12 gauge wire should be used. Do not ground TEC terminals marked "GND" or "S GND", these are Sensor Grounds and severe damage could result. NOTE: If your TEC is installed on an engine dyno it may be necessary to attach an additional ground wire between the engine stand and a good electrical, water pipe ground. The ground loop potential through the PC computer hookup can cause problems if old house wiring is present and lots of fluorescent lights are in use.

+12 Volt Power

Another source of problems lies in inadequate +12 volt power leads which cause voltage drops when high power devices such as coils or injectors turn on. All +12 volt wiring must be 12 gauge and have switches rated for 20 amps minimum. It is best to run separate power leads from a terminal very close to the battery. Avoid putting a high power fuel pump on the same circuit as the TEC. If long leads are used, a relay is recommended in the engine compartment. In older vehicles, ignition key switches are sometimes worn and have too much contact resistance or worse yet have resistance wire between them and the old ignition coil. To avoid problems it is recommended to use a power relay such as EMI P/N 91200 or similar. If the engine does not shut off when the key switch is turned off, disconnect the +12 volt wire from the relay and switch it back directly to the key switch. This is caused by not enough load to discharge the alternator field windings.

In some application with dual batteries it is not recommended to use diodes in the connection between the batteries especially in the grounds. If electrical noise tends to shut the PC communications down or cause resets a large (220uF, 50 volt or higher) capacitor is recommended across the TEC-I's red and black power leads or between the TEC-II's SW BAT and its black lead. Try to install the capacitor as close to the TEC as possible.

Fuses

Fuses are not required on the TEC's +12v red wire. Since fuses add series resistance they are a source for voltage loss. Fuses also serve as another source for failure. If current delivery is a concern, keep the wires from the battery to the TEC as short as possible, and use the fuel pump output to trigger an outboard relay for the fuel pump and injector power. This will take this current draw away from the TEC.

Special Notes on Dyno Use

In many engine dynamometer situations, an alternator is not used and a 120 VAC battery eliminator is desirable. In that case, it is recommended to use at least a 35 amp D.C. voltage power supply set at 13.8 volts output. These are available through most electronics outlets. Attaching a battery in parallel to the 13.8 volt power supply at the engine will also help, especially if a high power electric fuel pump is in use. A battery and standard battery charger will work, provided that the battery is in good shape and the charger is not set too high. If this method is selected, the battery may not last too long (i.e. 1 year) due to poor charge regulation. Never use just a battery charger; unfiltered D.C. may damage the TEC and produce poor results. Long wires to the control panel and back to the engine must be avoided. Erratic or no spark firing and a persistent "COM ERROR" may result. Use a power relay at the engine to avoid this. Take caution to prepare the starter ground return wire to the battery correctly to avoid sending starter current through the TEC chassis.

SPARK PLUGS, AND SPARK PLUG WIRES

Spark plug type and gap

Since the TEC puts out a significantly more spark energy than other ignitions it is not necessary to run a hot spark plug. Use of colder plugs may be necessary to disperse the increased heat created by the stronger ignition. The TEC contains sophisticated digital electronics, solid core wires will cause both EMI and RFI noise and must never be used.

It is recommended that you start with the manufacturer's specified plug gap, usually from .023" to .035". If the engine has a high compression ratio (over 12:1) or is highly boosted (over 14 psi) it may be necessary to decrease the plug gap if misfiring results. If no recommendation is available use the following as a guide:

High Power 75 to 115 HP per Cylinder	0.023" (0.6mm)
Alcohol High Compression	0.027" (0.7mm)
High Performance Street	0.031" (0.8mm)
Stock Type Low Output	0.035" (0.9mm)

Spark Plug Wiring Order

Electromotive's patented Ignition System fires each cylinder at every TDC, normally, two cylinders are fired by the same Coil. For example, a four stroke four cylinder engine, with a firing order of 1-3-4-2, has two cylinders (1 & 4) approaching TDC at the same time, one on it's compression stroke and one on it's exhaust stroke. The TEC fires both of these spark plugs simultaneously with coil A and 180 degrees later when 2&3 are approaching their TDC, the TEC fires coil B. When connecting your spark plug wires to the coils, begin placing the wires on the coils in the sequence of your firing order and refer to the coil firing sequences to follow for various TEC configurations.

Below you will find spaces to enter your engines firing order, and underneath these spaces, you will find the coil firing sequence for a full 720 degrees of crank shaft rotation. If you don't know your engines firing order, a list of popular firing orders will follow.

4 cylinder: Coil A @ TDC, B @ BDC **(A,B)**

Your Firing Order: _____
TEC Coil Connection: **A** **B** **A** **B**



6 cylinder: Coil A @ TDC, B @ 120° ATDC, C @ 240° ATDC (A,B,C)

Your Firing Order:

TEC Coil Connection:
A **B** **C** **A** **B** **C**

8 cylinder: Coil A @ TDC, C @ 90° ATDC, B @ BDC, D @ 270° ATDC (A,C,B,D)

Your Firing Order:

TEC Coil Connection:
A **C** **B** **D** **A** **C** **B** **D**

12 cylinder: Coil A¹ @ TDC, A² @ TDC(sensor 2), B¹ @ 120° ATDC, B² @ 120° after A²,
C¹ @ 240° ATDC, C² @ 240° after A². Essentially, a 12 cylinder is 2 6cylinder units.

Your Firing Order:

TEC Coils:
A¹ **A²** **B¹** **B²** **C¹** **C²** **A¹** **A²** **B¹** **B²** **C¹** **C²**

Common Firing Orders

<u>Engine</u>	<u>Firing Order</u>	<u>COIL</u>			
		<u>A</u>	<u>B</u>	<u>C</u>	<u>D</u>
8 Cylinder					
Most G.M. Chrysler and AMC	1-8-4-3-6-5-7-2	1&6	4&7	5&8	2&3
Ford 302,355,429,460,390	1-5-4-2-6-3-7-8	1&6	4&7	3&5	2&8
Ford 351W,400	1-3-7-2-6-5-4-8	1&6	4&7	3&5	2&8
Cadillac 368,425,472,500	1-5-6-3-4-2-7-8	1&4	6&7	2&5	3&8
MBenz	1-5-4-8-6-3-7-2	1&6	4&7	3&5	2&8
6 Cylinder					
Buick 3.0,3.8	1-6-5-4-3-2	1&4	3&6	2&5	
Chevy 2.8	1-2-3-4-5-6	1&4	2&5	3&6	
Ford 2.8	1-4-2-5-3-6	1&5	3&4	2&6	
Porsche 911	1-6-2-4-3-5	1&4	3&6	2&5	
4 Cylinder					
Most All	1-3-4-2	1&4	2&3		
VW Air Cooled	1-4-3-2	1&3	2&4		
Dual Plug 4 cylinder	1-3-4-2	1&4	2&3	1&4	2&3

Spark Plug Wires

Inexpensive, carbon core wires, 8mm or larger, are recommended for use with the TEC direct ignition system (3000 to 5000 Ohms per foot). Newer, spiral core type wire can be used, but Electromotive has not tried all of the wires available and can not recommend any specific brand wires. When selecting wires, the primary concern is RFI and EMI suppression. If you are running spiral core wire, and you experience spark scatter, or the TEC/HPV seems to lose RPM signal, you may want to consider switching to carbon core style wires.

Consider plugs and wires a maintenance item, to be replaced on a regular basis. Wires and ends should be checked periodically for signs of arcing. Replace them immediately if such signs are found.

Rotary Applications

Rotary Engines as those in MAZDA's RX7 will have two spark plugs per rotor housing, and these spark plugs will fire once per eccentric shaft rotation. Two-rotor Engines are phased 180 degrees apart, and three-rotor Engines are phased at 120 degree intervals. With Rotary Engines, the coils on the TEC will only go to one spark plug, the other coil terminal will be taken directly to ground on the engine block. The crank trigger wheel should be mounted to the eccentric shaft and a bracket must be made to hold the sensor(s). Every time the Eccentric Shaft comes to TDC, Rotor #1 is ready to fire and so is coil A. Coil B will fire in sync with rotor #2 at every BDC. Should a TEC-2 4cylinder Dual Plug, Dual Sensor be used, the second magnetic sensor will be placed a few degrees after the first, allowing for somewhere between 6° and 16° degrees of 'trailing ignition', this value is determined by the engine tuner / builder.

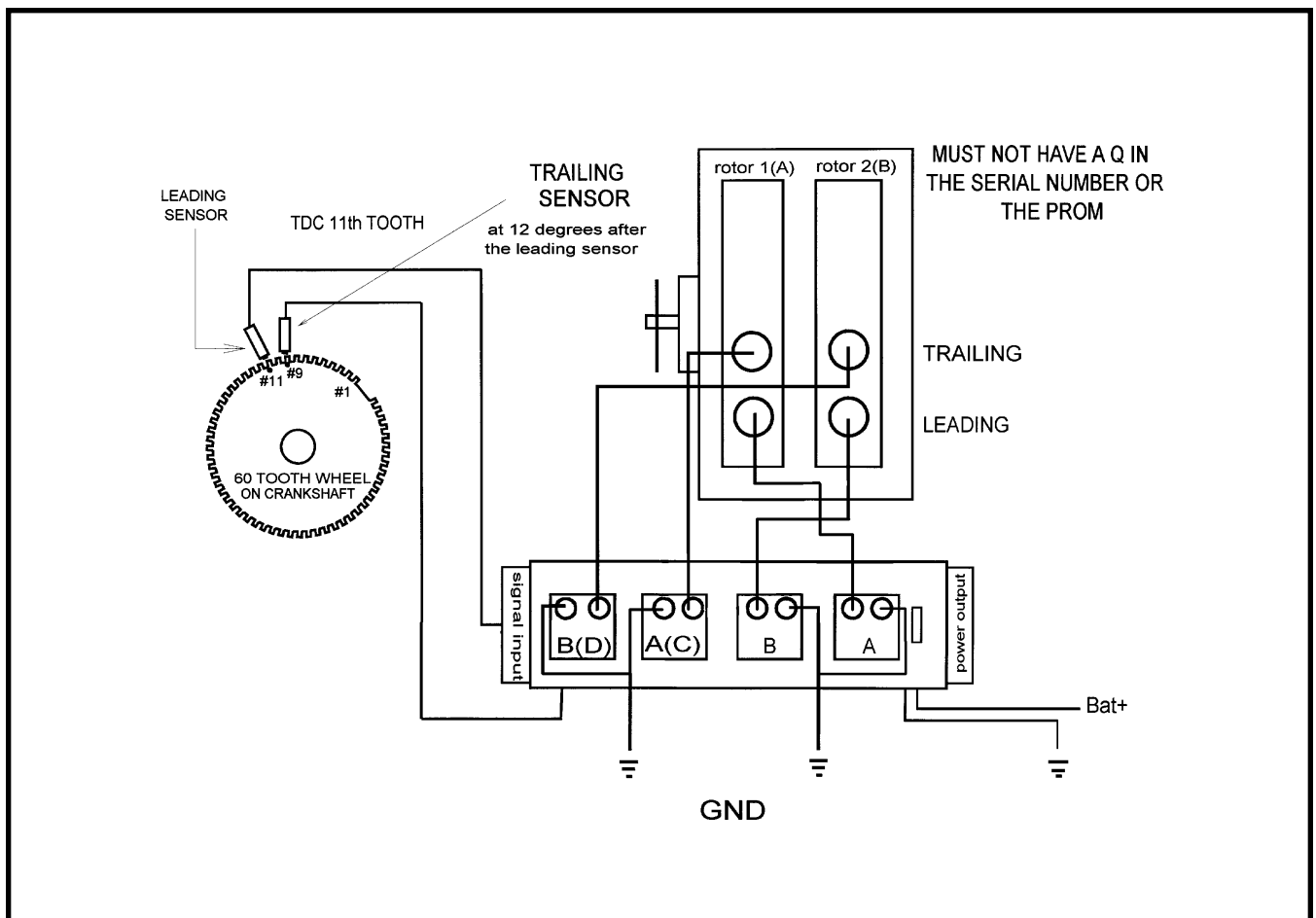
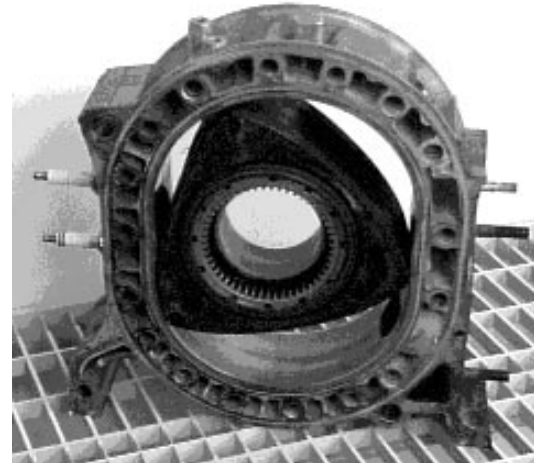

INJECTOR CONNECTIONS

When the injectors are hooked up, they are connected in a similar fashion as the Coils

4 & 6 cylinder TEC-II

Inj.1(A)... Pin 11

This is where the injectors for those cylinders connected to Coil A receive their ground pulses.

Inj.2(C)... Pin 12

This is where the injectors for those cylinders connected to Coil C receive their ground pulses.

NOTE: the Four Cylinder TEC-II does not use this pin in its standard configuration

Inj.3(B)... Pin 13

This is where the injectors for those cylinders connected to Coil B receive their ground pulses.

Inj.COM +... Pin 14

This is where all the injectors get their 12 Volt supply.

8 cylinder TEC-II

Inj.A... on 5 pin connector

This is where the injectors for those cylinders connected to Coil A receive their ground pulses.

Inj.B... on 5 pin connector

This is where the injectors for those cylinders connected to Coil B receive their ground pulses.

Inj.C... on 5 pin connector

This is where the injectors for those cylinders connected to Coil C receive their ground pulses.

Inj.D... on 5 pin connector

This is where the injectors for those cylinders connected to Coil D receive their ground pulses.

Inj.COM +... on 5 pin connector

This is where the injectors receive their 12 Volt supply.

NOTE: In most applications it is recommended NOT to use this terminal for the Voltage supply for the injectors, because this only drains Voltage potential from the Coils.

TEC-I 6 cylinder Dual Plug, 12 cylinder and TEC-R88

These systems label their injector grounds as FI1, FI2, FI3 etc.. In most cases your TEC one Has two of each FI1, FI2 etc., on the 12 cylinder TEC-I, they are all used with two injectors at each terminal as follows:

FI1 to those cylinders connected to 'A' coils, and there are two 'A' coils on a 12 cylinder.

FI2 to those cylinders connected to 'B' coils, and so on.

On 6 cylinder Dual Plug and R88 users we have provided a backup set of injector drivers, or if the injector manufacturer specifies a 4 amp peak and 1 amp hold for each of their injectors, you will be able to conform to those specifications by hooking one injector to each driver.

TEC SENSORS

Manifold Absolute Pressure (MAP)

The MAP sensor is an absolute pressure sensor and the TEC software displays the Manifold Absolute Pressure in kPa or kiloPascals. 0 kPa = 29.9 inches of Vacuum and 100 kPa = one Bar or one standard Sea-Level atmosphere. When Tuning with kPa, it is important to note that a normal idle vacuum of 19 inches is approximately 33 kPa and a Wide open throttle condition usually displays the current atmospheric pressure of somewhere around 100 kpa. The following casting Numbers can be found on the MAP sensors used by Electromotive and have the following uses.

- | | |
|--|--------------------|
| 1 Bar = For Naturally Aspirated Engines | Casting # 039 XXXX |
| 2 Bar = For Forced Induction Engines with up to 15 psi boost | Casting # 886 XXXX |
| 3 Bar = For Forced Induction Engines with up to 30 psi boost | Casting # 749 XXXX |



MAP Sensor Plumbing for Individual Runner Intakes

If your engine is equipped with individual intake runners, not sharing a common connection or a 'plenum' it will be necessary to install a balancing tube for MAP sensor. Do not plumb the MAP sensor into just one cylinder since the pressure pulsations will disrupt fuel computations. Attach at least 1/8" I.D. tubing from each cylinder to a common "log" of at least 1/2" I.D. If an IAC motor is to be used on the same vacuum log, double the diameters.

Connect the attached cable on the TEC to the MAP sensor. This is the cable about 3 feet long with a 3-pin green connector on it. If a 2 or 3 bar turbo pressure sensor is in use, the connector will be orange and keyed differently.

Mass Air Flow (MAF) Sensor

If Mass Air Flow (MAF) has been chosen over Manifold Absolute Pressure, several installation procedures must be observed. The first and most important consideration is that no unmetered air must be allowed to enter the cylinders. All air used by the engine must first pass through the MAF sensor.

MAF Wiring

Two versions of the Ford MAF sensor are available: a four wire and a five wire. Follow these wiring instructions:

Connect the Ground to a screw on the TEC and the Signal out to the TEC's MAP input (terminal 3). A TEC-1 MAP input is the white wire on the MAP cable. Attach pin A to a source of switched +12 volt.

Attach the MAF to the Throttle body input per the diagram below, the arrow on the unit shows the direction of the air flow. The MAF must not have any direction changes a least 6 inches before and after it passes through the sensor. Air turbulence inside the MAF cause unstable and unreliable Sensor Values.

PCV Plumbing

A fresh air mini filter can not be used on the valve covers as this will cause unmeasured air to enter the intake manifold. For engines with two valve covers, plumb the opposite valve cover from the PCV valve to the outlet side of the MAF. Use a standard PCV valve on the other valve cover and plumb it to the intake manifold. Use opposite ends of the valve cover on engines with one cylinder head.

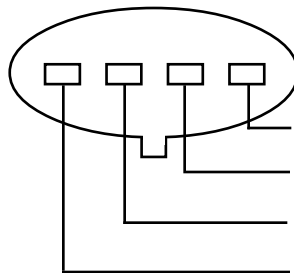

- A = Switched +12 volts
- B = Ground
- C = Ground
- D = Signal Out (MAP terminal on TEC)

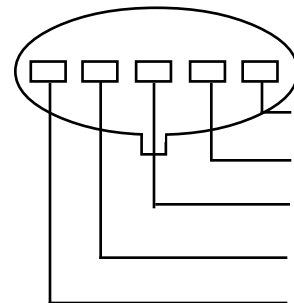

- A = Switched +12 volts
- B = Ground
- C = Ground (tie C and D together)
- D = Ground - tie to C
- E = Signal Out (MAP terminal on TEC)

Idle Air Plumbing

The idle air supply must be plumbed from after the outlet side of the MAF.

Software

In order to use the MAF feature you must have either PAFZ or Super*B calibration software.

Coolant (CLT)

The coolant sensor is a GM part number 25036979 and can be obtained from Electromotive. It has a 3/8 NPT thread and it can be screwed anywhere into the engine water jacket before the water enters the radiator. Use teflon tape or pipe dope to seal the threads. To test the sensor verify a reading of about 2900 ohms at room temperature (72°F).

Wire the sensor with the supplied cable and connector to the two terminals marked "CLT" and the adjoining "GND" terminal. This cable has a black 2 pin Metri-Pack connector on it. Polarity does not matter.



Manifold Air Temperature (MAT)

The manifold air temperature sensor is similar to the CLT except it is inserted in the intake airstream. It is optional and can be disabled in the software. A GM P/N 25036751 is used. It is useful for everyday street machines that must run in wide temperature ranges.

If a turbo is used put the sensor after the turbo and intercooler. A 3/8" NPT tapped hole is required. Do not install the sensor where fuel droplets can fall on it and cause evaporative cooling

Wire the sensor with the supplied cable and connector to the two terminals marked "MAT" and the adjoining "GND" terminal. This cable has a grey 2 pin Metri-Pack connector on it and wire polarity is not required. To test the sensor verify a reading of about 2900 ohms at room temperature (72°F).

Auxiliary Rev Limiter

A secondary function of the MAT input is to engage the auxiliary rev limiter. If a switch is attached across the MAT to GND terminals and closed (MAT grounded) the TEC will engage the auxiliary rev limit speed. This function can be used for Drag Racing launch control or valet mode power limiting.

Heated Exhaust Gas Oxygen Sensor (HEGO)



The EGO sensor is essential for doing closed loop feedback fuel control as found on all late model street vehicles. It is the key sensor for producing good power with least emissions. It further can be used to aid in calibration of both street and off-road vehicles. Several styles exist but only two basic types are commonly used. The simplest is the unheated single wire EGO sensor (GM P/N 8990741). The single wire can be used only if the EGO sensor is mounted in the exhaust manifold or within 10 inches of the manifold. If the EGO is mounted farther away or after a turbocharger a heated sensor should be used. PAF and PAFZ systems require a heated sensor.

EGO Sensor (Unheated)

The unheated, 1 wire oxygen sensor is the easiest to use since all it requires is installing an M18-1.5 (sparkplug thread) boss in the exhaust. Use an M18-1.5 nut or an EGO sensor weld-in adapter available from Electromotive. Mount the sensor boss in an accessible spot close to the outlet of the exhaust manifold. Do not mount it more than 10 inches down from the exhaust manifold. If a good welder is not available it may be possible to obtain an exhaust manifold or tubular header equipped with an EGO fitting. Install the one wire EGO with anti-seize compound, being careful not to get any of it on the sensor element, and run the wire up to the TEC terminal marked "EGO".

Throttle Position Sensor (TPS)

The Throttle Position Sensor (TPS) tells the TEC when rapid accelerations or decelerations have started and if the engine is at either idle or wide open throttle. It is a variable resistance potentiometer which is powered by +5 volts from the TEC and sends out a signal that increases in voltage as the throttle is opened. Any three wire potentiometer type TPS may be used.



Install the sensor so that the TPS lever rotates with the throttle shaft and moves the sensor at least 80 degrees rotation from idle to wide open throttle. Plug the second long, 3 foot cable on the end of the TEC to the TPS. This wire has a 3 pin black Weatherpack connector with a black, white and red wire in it. Do not confuse it with the short magnetic sensor cable. It is possible to get the voltage signal reversed. To check, measure the resistance between the A and B (center) terminals on the TPS. It should be very low ohms at closed throttle and very high at wide open. Furthermore, if the Engine Monitor screen shows a high TPS voltage at closed throttle and the voltage drops as the throttle is open, it is reversed. The TPS output signal voltage should increase as the throttle is opened. If the reverse is found, correct the problem by swapping the red and black wire positions in the TPS cable. The idle position voltage of the TPS is not critical since it can be corrected for in the TEC software.

Knock Sensor (optional)

The Knock Sensor is a microphone that is mounted into either the engine block, intake manifold or head. G.M. P/N 1997562 is recommended. Some other piezoelectric types are available but generally most of the one wire sensors from GM will work. Find an existing plug in the engine block with a 3/8" NPT thread. Remove the plug and replace it with the knock sensor. Common plugs are found in the left and right side of the block and are water jacket drain plugs. Locate the sensor in a central location and avoid a location near the alternator. If no 3/8" NPT locations are available, a less desirable solution is to mount the sensor in a block of aluminum and bolt the block to the engine block. Wire the sensor to the terminal marked "KNK" and turn this function on in the software.



OUTPUT DEVICES

The TEC includes outputs which are available to improve the operation and flexibility of your engine. While not required, they make the complete system more drivable and user friendly.

Idle Air Control (IAC) Motor

The Idle Air Control Motor replaces the high speed idle cam (choke) and works by passing extra air around the throttle plates for high speed idle. The four wire motor must be a GM type IAC motor. If a GM or certain Holley Throttle Bodies are used they may have provisions for this motor. If the throttle body does not have an IAC fitting, Electromotive can supply an IAC motor body with fittings to plumb the idle air into the manifold.

Installing the Motor

With the motor separate from the throttle body push the spring away from pintle end and screw the pintle into the motor so that it bottoms out. Screw the motor in the large threaded hole. For IAC motor bodies, attach a 3/8" NPT hose barb on the other two fittings. Take care not to turn the pipe fitting in too far as it will hit the IAC motor's pintle and jam it. The end port must be plumbed into a common port of the intake manifold plenum. Use at least 1/2" ID hose. If it is a dual plane manifold the idle air must get equally into both planes. The IAC body must receive filtered air from the air cleaner.

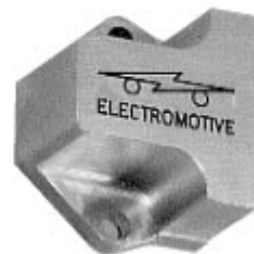

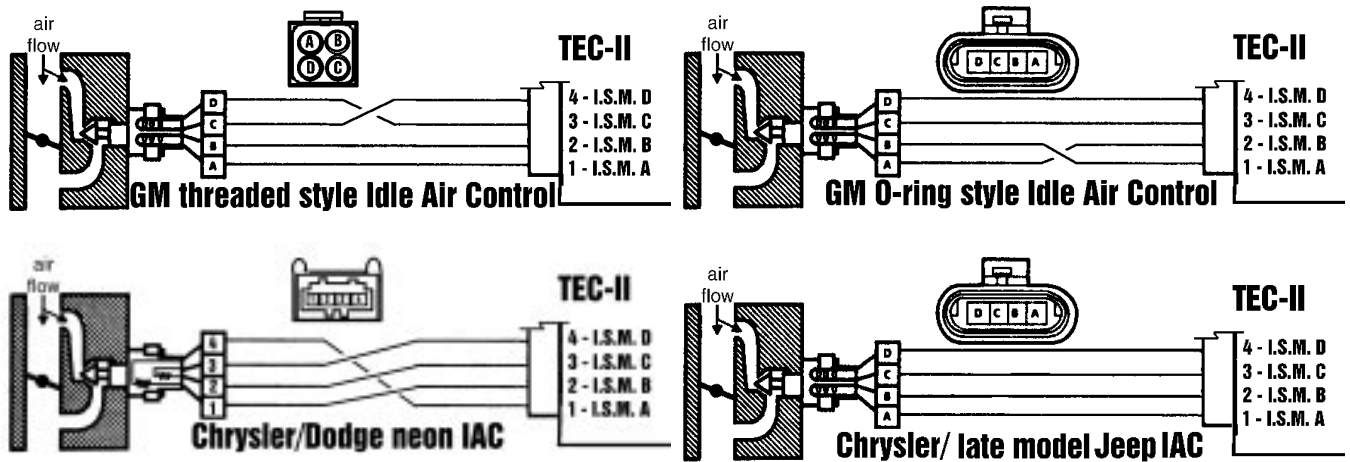

See the software section for procedures on setting the control parameters for the IAC motor.

Special precautions must be made if the engine is equipped with individual intake stacks per cylinder. The idle air must be sent to each intake through a large balancing tube. The inside diameter of the balancing tube must be at least 1/2". Actual requirements will vary with displacement. Do not send the idle air into the intake manifold via the same pipe as the MAP sensor.

Wire the IAC motor using the appropriate 4 pin connector and wired as shown.

Caution: Turn the TEC off before unplugging, plugging or modifying any cables. A slight short between any wire or to ground will damage the electronics in the TEC.

Fuel Pump Relay Installation

The TEC has the capability of turning the electric fuel pump on and off. This is a desirable feature since the TEC turns the fuel pump on at key-on to pressurize the fuel system and then turns it off if the engine has not started to rotate in 20 seconds. This prevents excessive battery drain if the key is left on.

TEC-I Only

The fuel pump relay output is a pull to ground type output and must be attached to a relay with no less than a 50 ohm, 12 volt coil. A good relay is the G.M. P/N 12034544 which can be purchased from Electromotive. If the relay does not have an internal surge suppression device the F.P. Relay output must be protected from surges by a diode. Failure to protect the TEC from surges may damage it.

Install the fuel pump relay under the hood and wire the F.P. RELAY output on the TEC directly to one side of the relay coil. Use a suppression diode if necessary. The other side of the relay coil must be connected to +12 volts. Attach one contact of the normally open side to +12 Volts. No fuse is required but a fusible link is a good idea. The other contact will go directly to the + side of the electric fuel pump. Ground the - side of the fuel pump.

TEC-II Only

The TEC-II incorporates an internal relay rated at +12V at 8 amps. Unlike the TEC-I, which supplies a grounding contact for an external relay, the TEC-II provides +12V output which can be run directly to the + contact on your fuel pump, however, it is recommended you use a relay anyway, since it is cheaper to buy a relay than to have the TEC-II repaired due to a burnt out PC relay. High volume fuel systems, especially any running more than one pump, must still use a relay. The +12V from the TEC-II should be used to energize the relay's coil.

A separate relay for the fuel pump is recommended on all but the smallest fuel delivery systems. If using a relay, running power from the relay to both the fuel pump and the fuel injectors is recommended.

Check Engine Light

A check engine/diagnostic light output is available on the TEC. It comes on if there is a sensor failure or if the engine is not rotating. It also flashes out specific codes if a sensor failure has occurred.

Select a bulb rated at 250 milliamperes or less. This is no larger than a type 158 bulb. An LED is OK if it has a series resistor in it. The output is a pull to ground type and can be wired directly to the bulb. The other side of the bulb must be wired to +12 v switched battery. Mount the bulb on the dash or under the hood. If it is visible you can tell if your TEC is working just by glancing at it while starting the engine.

Failure codes which can be set by the TEC:

- 1 CLT this code is set if the coolant temperature sensor circuit is either open or shorted to ground.
- 2 MAT this code is set if the manifold air temperature sensor circuit is either open or shorted to ground.
- 3 MAP/MAF this code is set if the MAP sensor or MAF sensor voltage is either too high or too low.
- 4 EGO lean too long this code is set if the oxygen sensor shows lean for more than a specified time.
- 5 TPS this code indicates a throttle position voltage higher or lower than specified
- 6 LOB this code is set if the TEC voltage drops to around 8 volts (this is SW BAT on a TEC-II).

General Purpose Output (GPO)

If your TEC-1 is equipped with a spare output it is possible to operate any number of power accessories such as a turbo waste gate, nitrous oxide solenoid, air injection bypass or a shift light. The GPO is a 0.5 amp driver, it will complete the path to ground for any electrical or electronic device with at least 36 ohms of circuit resistance. The other side of the device must be attached to switched +12 Volts. Should the solenoid or other device have a higher current demand than 0.5 amps or a circuit resistance of less than 36 ohms, use an op-amp or relay to provide the current required. The most commonly used frequency for the GPO is 31 Hz, but the TEC provides other options. Later models of the TEC-1 have a high powered GPO, in essence a fuel injector driver with 4 amps peak and 1 amp hold characteristics and can be used to power 2 additional injectors.

WIRING DIAGRAMS

The following pages will identify the specifics to wiring your Electromotive Total Engine Control system or HPV-3b

Page 41:

TEC I, 6 Cylinder Dual Plug

Page 42:

Tec I, 12 Cylinder

Page 43:

TEC I 12cylinder used as 3 Rotor system

Page 44:

TEC R-88

Page 45:

TEC II, 4 & 6 Cylinder

Page 46:

TEC II, 8 Cylinder

Page 47:

TEC II, 4 Cylinder Dual Plug (single and dual sensor)

Page 48:

HPV 3b

TEC I, 6 Cylinder Dual Plug

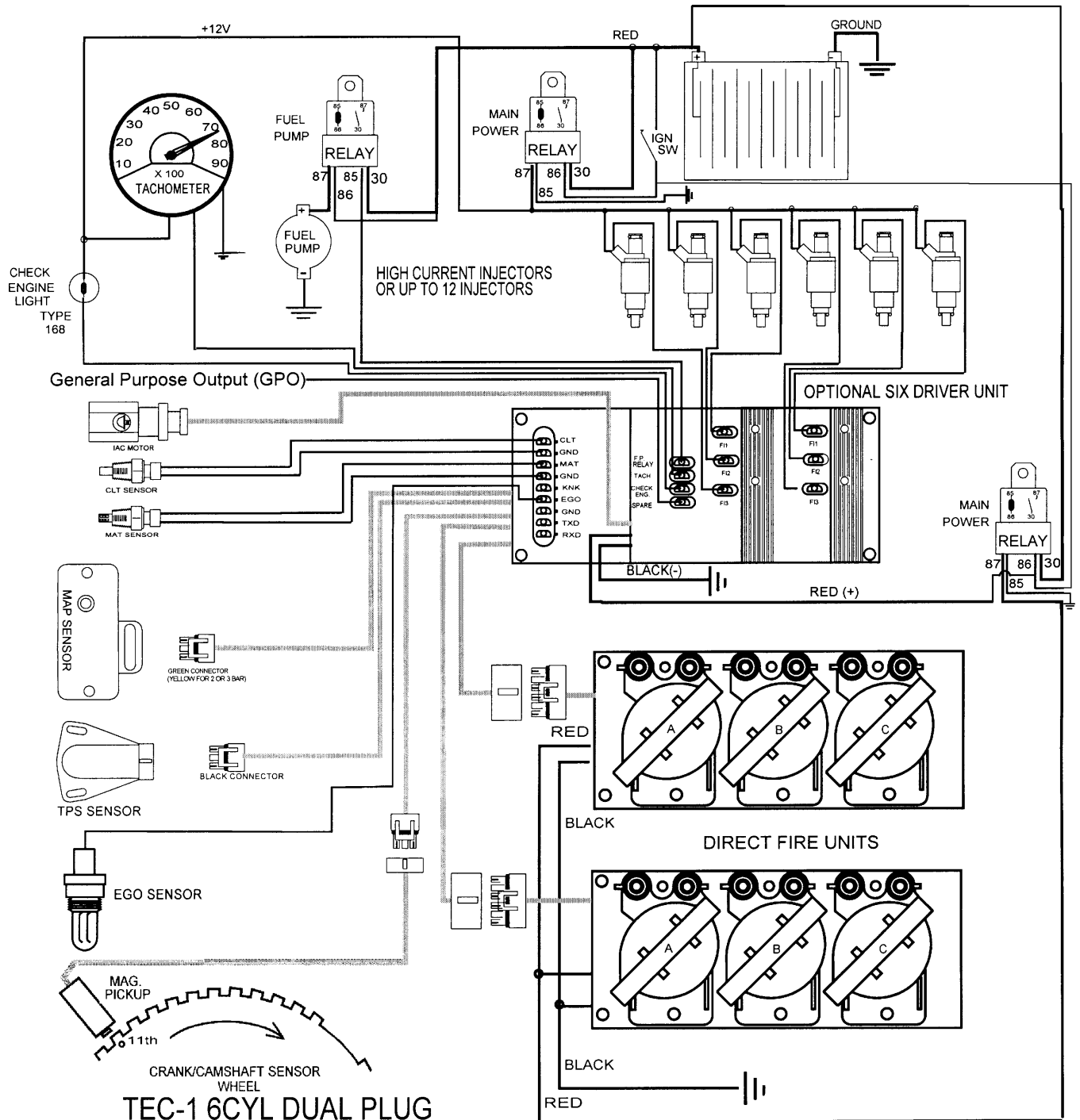

Tec I, 12 Cylinder

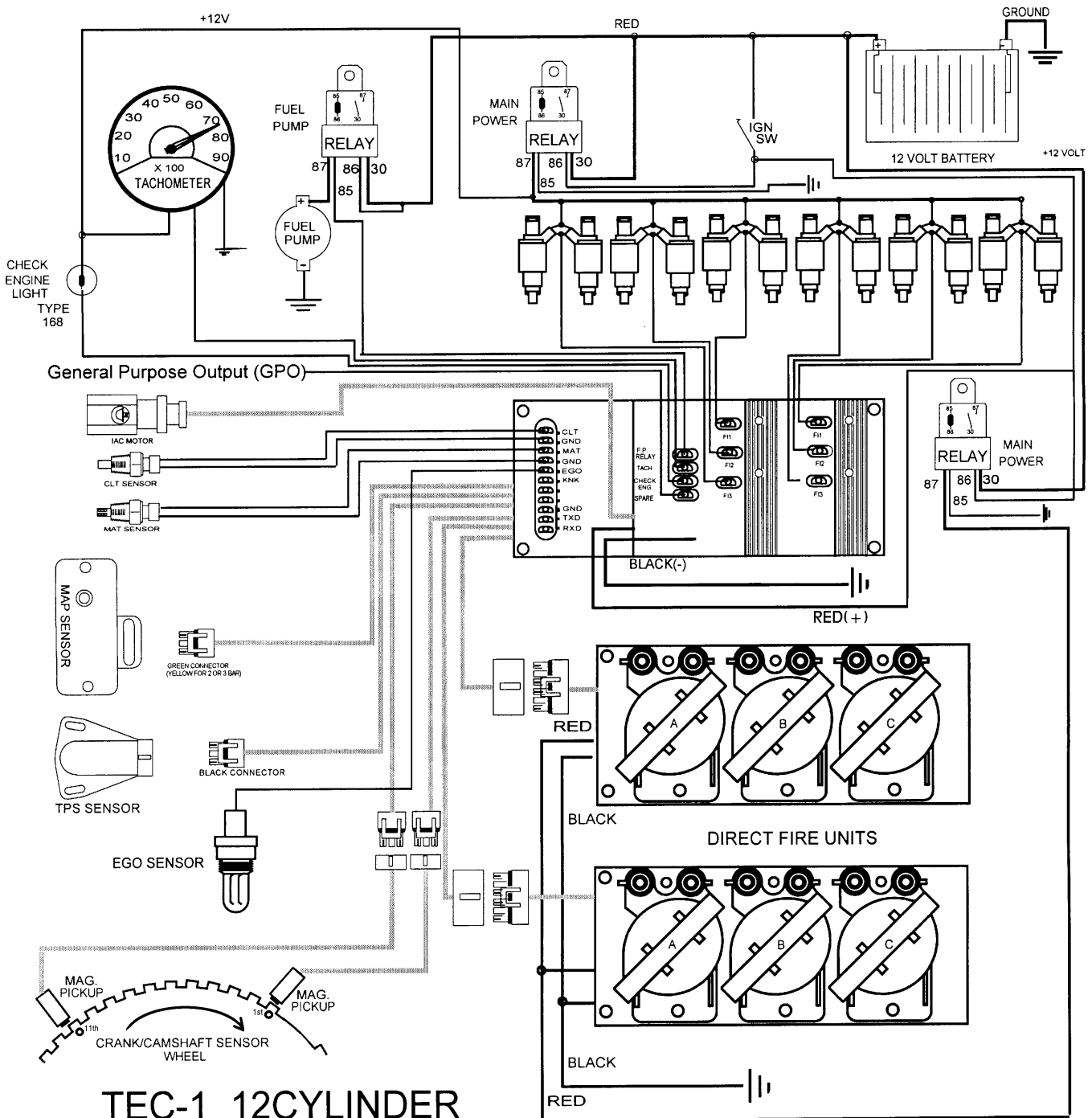

TEC-1 12CYLINDER

TEC I, 12cylinder used as 3 Rotor system

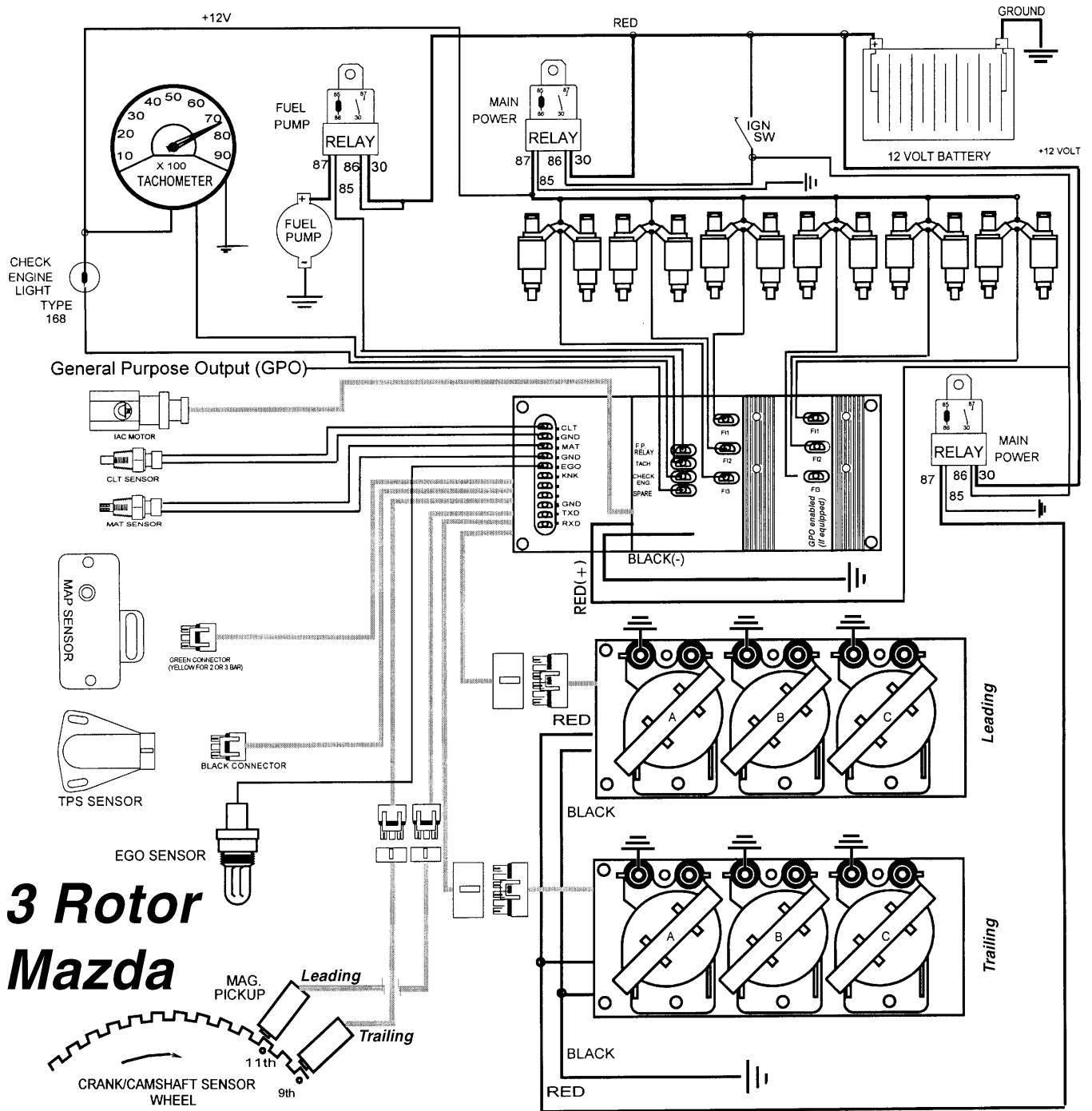

**3 Rotor
Mazda**

TEC R-88

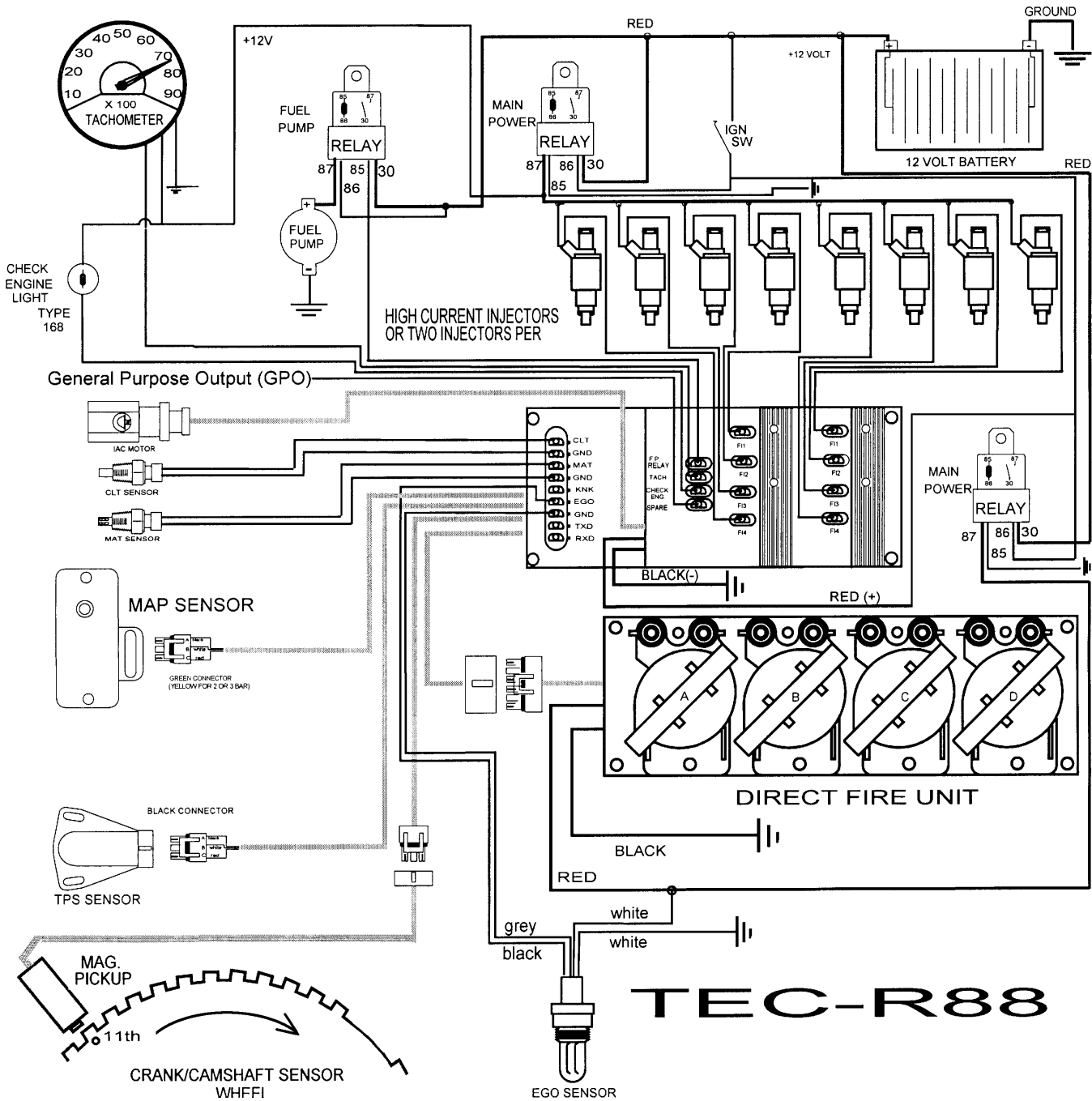

TEC-R88

TEC II, 4 & 6 Cylinder

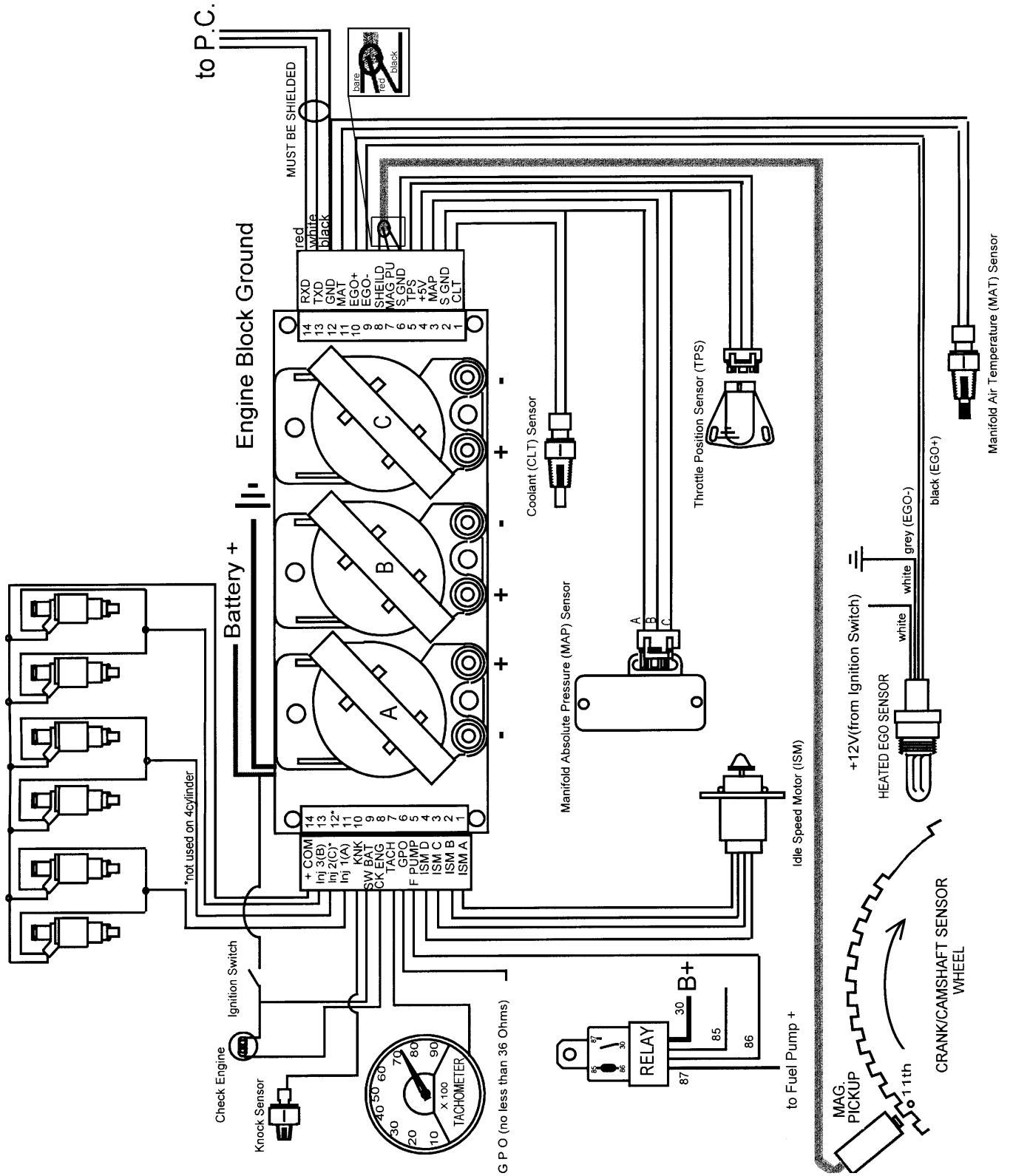

TEC II, 8 Cylinder

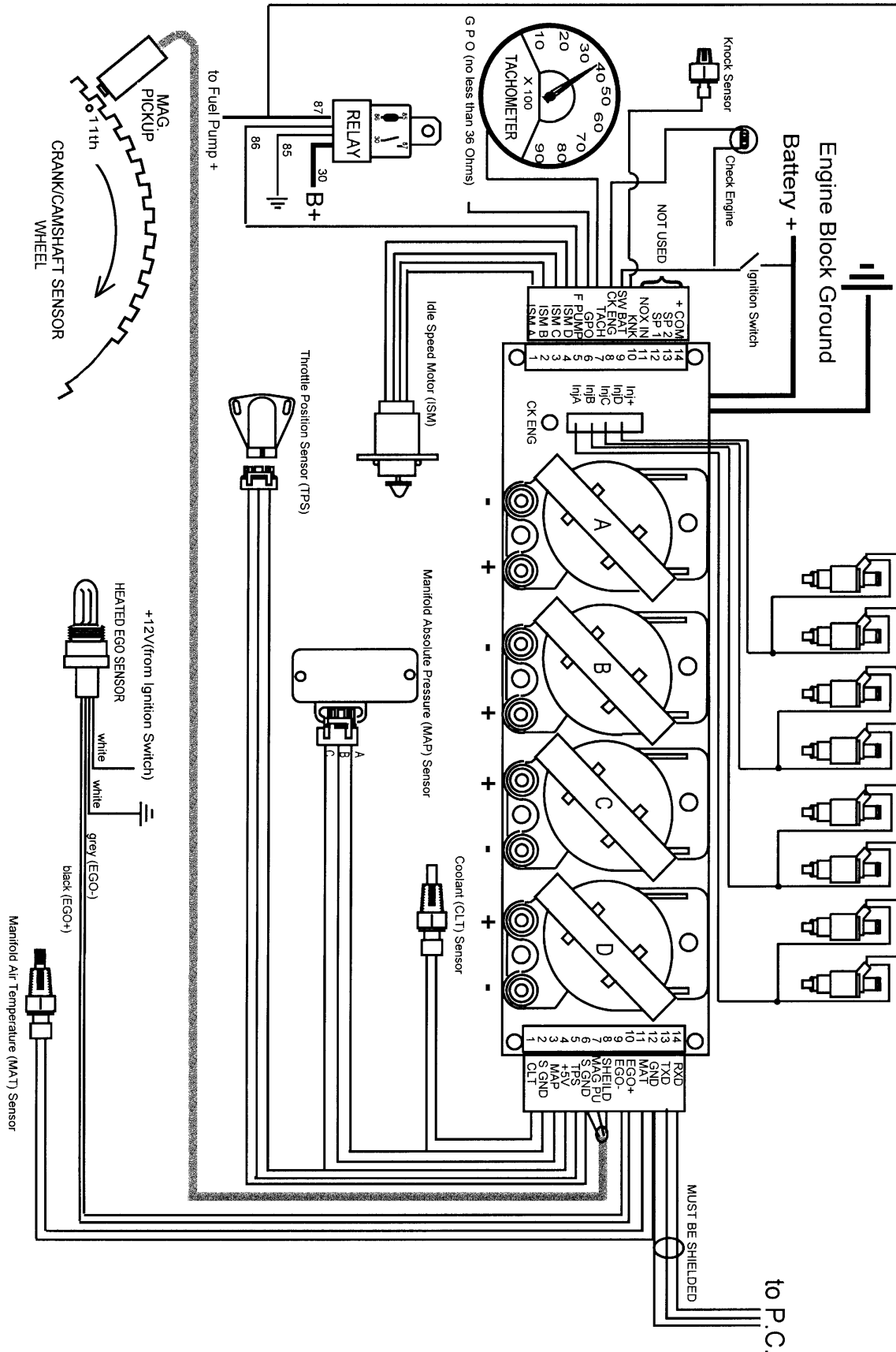

TEC II, 4 Cylinder Dual Plug (single and dual sensor)

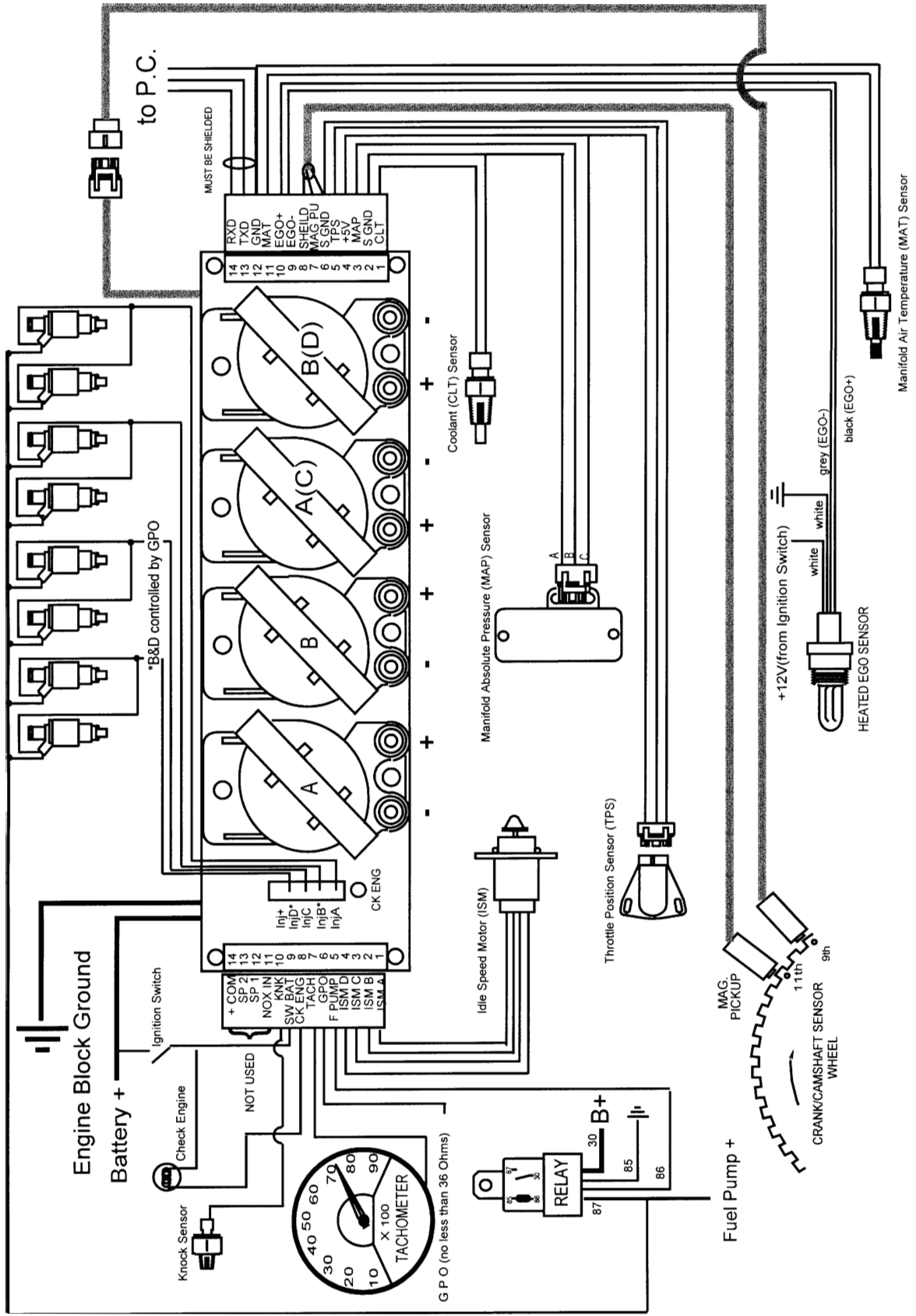

HPV 3b

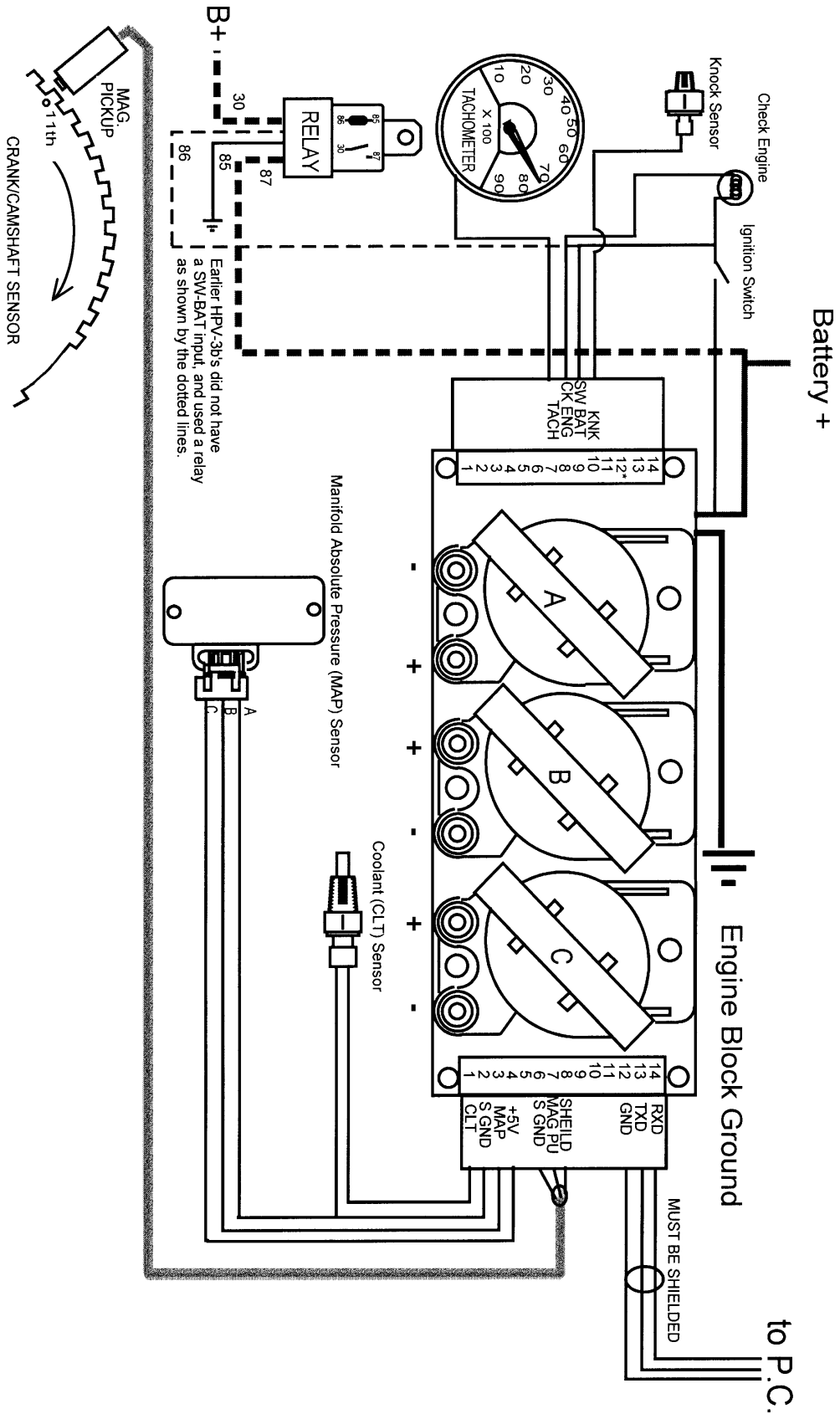

WORKING WITH THE CALIBRATION SOFTWARE

PC Selection

System Requirements

Electromotive Calibration Software for the TEC 1, TEC 2 and HPV 3 requires an IBM or compatible PC with a 286 or better processor, preferably with a hard drive, and running a copy of DOS version 2.0 or higher and at least 1 MB of memory. These system requirements are intentionally kept low, so that you don't have to risk an expensive computer at the racetrack.

Windows Users

If you use a Windows operating system on your PC you should shut down windows and restart in DOS to operate the calibration software, you may experience 'com error' problems while working in a 'DOS shell'.

Communications Port Selection

The TEC calibration software allows you to toggle between 'com 1' and 'com 2' by simultaneously holding down 'Ctrl' and 'P'. Check your current port selection when communication problems arise. At this point, the TEC should be completely wired, including the communications cable. Communications will be established, information which is required before starting the engine will be recorded and entered into a calibration file.

Start the calibration software with the supplied base calibration. Bring up the Engine Monitor Screen, correct any condition causing a sensor to show 'failed' and begin to record such information as closed throttle voltage.

Now is a good time to make sure you are comfortable using a PC. You should be familiar with basic DOS commands such as copying, deleting, and running different DOS files. Your PC should meet the minimum requirements, and the TEC and PC should have communication established.

Computer Basics

Back Up Your Software

Make a working copy of the original disk sent to you. Create a new directory on your hard drive and change to that directory. Place the original calibration software disk in the floppy drive (A or B) and enter "COPY A:*.*)" or "COPY B:*.*)" depending on which drive you put your disk in. To make a floppy disk backup, you may use the "DISKCOPY" command. Put the original disk in a safe place and always use the working copy. To preserve the base line calibration, use DOS or the TEC software to create a new file to work from. In DOS, simply use the "COPY" command as follows:

```
COPY SUPER.BIN NEWFILE.BIN  
COPY SUPER.S19 NEWFILE.S19
```

Alternatively, start the TEC calibration software by entering the name of the software you are using, and either use the cursor arrow keys to move the cursor to "Edit a file" or type **E** and hit **Enter**. When the program asks for a calibration name, type the name of your software again (SUPER, PAF, etc. if this is the first time you are running the software) and then **Enter**. Using the arrow keys, go to "CHange Name loaded bin file" or type the highlighted "H" to rename the file.

Minimum Required Hardware

The software has been designed to run on any recent computer (286 or higher) with at least 512K of RAM and a serial port configured as COM1 or COM2 (COM2 available with *Super*Blend* and *PAFZ* only). Machines with a hard disk are preferred, but not mandatory. The supplied cable connects the RS232 (serial) port on the computer to the **TEC**.



Compatibility

In order for the PC to talk to the **TEC** the **TEC** must have a compatible PROM inside of it. Inscribed on the side of each **TEC** will be a PROM I.D. number. Only the corresponding calibration software should be used.

Calibration

(Executable) File

Works with TEC PROM

CAL	23D	(Obsolete)
PAF2, PAF2G	34Txx	xx is any version like 1B, 2B... (Discontinued)
PAFZ2, PAFZ2G	PAFZ	
PAFB (PAF*Blend)	PAFB	
SUPER2, SUPER2G	33Txx	xx is any version like 1E, 2E...
SUPERB2 (Super*Blend)	BLEND	
HPV3G (HPV-3B)	22x	x is any version like A, B...

Do not use calibration software not matched correctly to a PROM. Erratic operation will result. Furthermore, if you have an old calibration file and are now using a newer PROM or disk the old calibration file will not be compatible. Even if the calibration downloads into the TEC, the monitor will not come up and engine will not run correctly. As soon as you monitor the engine a com (communications) error will result if you have incompatible software.

If you are updating old files to new software, you must enter all the information into the new calibration. Please check with Electromotive for compatibility information before updating.

Running the Calibration Software

Once in the proper directory, start the calibration software by typing the name for the product you have. See the list above for valid names. The computer then will ask what kind of monitor you have. Type **b** for monochrome or **c** for color.

The computer will display a brief message with a border around it (**First Screen**) for four seconds. Confirm the version number. After four seconds, the **Main Menu** screen will appear. A flashing cursor will appear next to the first selection on the screen. To select a command, move the cursor to that command with the up and down arrow keys and press **ENTER** or type the highlighted letter from the desired command line. The various options are detailed below.

Edit an Existing Calibration

This command opens a previously saved calibration file. The calibration software disk includes a starting calibration with a name similar to your executable file. If you have **PAFZ IIG** software, type **PAFZ2G** the first time you go to edit your first calibration. If you have **Super*Blend II**, the base file will be **SUPERB2**. You should immediately save this file to one of your own designation, as discussed earlier. Keep the original as a base line, and use the new file with your designation as the working calibration.

Under most circumstances, the name of your current, working file will be displayed. Enter "Y" to edit this file. *If you enter a wrong name, the software will ask you if this is a file to be converted from a different version of software or a new file, unless you are converting a file from PAF to PAFZ or to PAFB, do not use a file like this, don't enter new values into a zeroed calibration file, always use an EXISTING calibration file and change the default values. A file starting with all zeros in the advance table will not include some of the sub-information the TEC needs to run properly.*

View an Existing Data File

This command allows the viewing of previously recorded data. This applies only to: **PAF*Blend**, **Super*Blend II**, **PAFZ II G** and **Super II G**. Look for additional info in the data logging section.

Program TEC

To move the data you enter on your computer to the TEC, the TEC must be programmed. Make sure the cable is connected and use this command to send your new calibration to the TEC's memory.

Monitor Engine Functions

As with the program function, there must be a good connection between the TEC and your computer to allow communication. By selecting Monitor Engine Function, you will be able to gather several pieces of information necessary before starting your engine for the first time. During start up and running, this feature will allow you to watch, in real time, exactly what your engine is doing. Changes to fuel flow and ignition timing may also be made through the engine monitor screen, while the engine is running. NOTE: Some calibration values are needed for the engine monitor to display all info properly, i.e. duty cycle reference number and MAP bar number, first go to edit an existing calibration, so that the monitor screen can retrieve this information.

Print Calibration File

Selection of this function will allow you to print out a complete calibration. The calibration will be four pages long. A print out of the base calibration as supplied with your software should be kept in your files for reference.

Display Files

Use this command to see what calibration files are currently on the disk in your current directory.

DOS Access

If you want to go out to the DOS command line select "DOS Access." To return, type **EXIT**. For more information on DOS commands see your DOS manual.

Warning: While in the DOS Shell do not enter the name of the program you are using. This would create another copy of the program in RAM.

Data Graphics

If your software includes Data Logging and graphics, this command will take you into the logging process. You will be prompted to supply a file name under which to store the data, and the speed at which to sample.

Exit to System

Returns you to your operating system.

ESC = EXIT

At the bottom of the screen is a command line with several additional options. The ESC key exits the program.

Ctrl + P = TOGGLE COM PORT = COM1

PAFZ and Super*Blend offer the choice of COM port 1 or 2. By hitting both the CTRL and the P keys simultaneously, you may switch between these two ports. The command line also displays which port is currently being used for communications.

Ctrl + A = TOGGLE MODE = MAP

The user may choose between Mass Air Flow (MAF) or Manifold Absolute Pressure (MAP) inputs in



PAFZ or Super*Blend. The choice is displayed on the command line.

Ctrl + Z

While in the calibration software, CTRL + Z allows direct saving and downloading of your current calibration.

Files

Always use a new file for each modification. Use an appropriate name, or part of a name, and a number, so you can keep track of the progression of tuning changes.

EXAMPLES: 350.bin, 350A.bin, VW#1.bin, JIM1.bin, etc.

Keep a log of all the changes made. Not every change will make things better, and even just a few simple notes will allow you to get back to a starting point quickly and easily.

If something does not make sense, it is quite likely incorrect. This may sound simple, but it is an easy axiom to forget. If the engine is running lean, for example, and increases in TOG do not provide adequate enrichment, there is probably some other reason. In this case, an air leak or undersized fuel system could just as easily be at fault.

Communications

At this point, the TEC should be completely installed and ready to power up. Attach the supplied Computer Hookup Cable to your computer's serial (COM1 or COM2) port. The connector may either be a DB-9 pin connector or a DB-25 pin. Adapters are available at your local computer store if you have the wrong size. Connect the three loose wires goes to the TEC as follows:

Red to the RXD pin on the TEC
White to the TXD pin,
Black to the GND pin

Computer Hook-Up Cable

If you must make a cable from scratch, use these connections:

DB - 9 Pin:		DB-25Pin:	
Pin 2	= White (TXD)	Pin 2	= Red (RXD)
Pin 3	= Red (RXD)	Pin 3	= White (TXD)
Pin 5	= Black and Shield (GND)	Pin 7	= Black and Shield (GND)
Jumper Pin 7 to 8		Jumper Pin 4 to 5	

Communications Port Selection

It is now possible to change your P.C.'s serial communications port assignment from Com Port #1 to Com Port #2 without leaving the TEC software. To do this, while in the main menu, hit "Ctrl" and "P" at the same time. The com port you are now on is found at the bottom of the screen. Now when either down loading or engine monitoring is done the new com port is activated. This allows using two TEC-s on the same computer without changing cables.

Power Up

It is now time to power everything up. The TEC should be completely installed, the computer should be hooked to the TEC with the calibration software running.

Turn the ignition switch on but do not crank the engine. (key on, engine off)

The **MAIN MENU** for the TEC should be displayed on the computer screen. At the bottom of the screen look where it says "Ctl+P = TOGGLE COM PORT = COM1." If you have the TEC communications

OFF = 14.655 MS						ON = 5.046 MS						(25.7% ACTIVE)					
ERPM				MAP				CLT		EGO VLTS		MAT					
3055				100.0 KPA				70 °C		0.00		25 °C					
ADV				GAMA		EGO CR		DS AFR		AC AFR		TPS					
23 °				1.00		0.00		14.64		21.46		2.41 UDC					
KNOCK = 0				GPO 0.0%				EGO SEN = LEAN				BAT 14.0 UDC					

1. SET ADVANCE TO ZERO
2. CLEAR ZERO ADVANCE **
3. ADD FIXED ADV/RTD (0.00 °)
4. ADD GAMA OFFSET (0.000 GAMA)
5. CHANGE TOG (7.000 MS)
6. CHANGE INJ. OFFSET (0.000 MS)
7. CHANGE MAP BAR # (1)
8. CHANGE GPO OFFSET (0.0%)
9. CHANGE AFR OFFSET (0.00)

FAILED		DISABLED	
		NONE	

cable hooked to COM2, hit the "Ctrl" Control key and the "P" simultaneously. The message at the bottom of the screen should now read "COM2." Move the cursor to **Monitor Engine Functions** and press **ENTER**. The display will change to **ENGINE MONITOR SCREEN**. It is also possible to hit **M** to jump to the Monitor Screen without using the cursor.

The Engine Monitor screen is divided into four main sections:

- Intermittent failures
- Run Time display
- Sensor Failure-Disable
- Calibration Aids

While in the ENGINE MONITOR SCREEN, you may want to bounce in and out of the EDIT AN EXISTING CALIBRATION fields, this is achieved by simply typing 'E', if you have not entered the EDIT menu before this, you will be asked the name of the file you wish to edit. The MONITOR ENGINE screen will not display injector ON TIME and DUTY CYCLE information at the top unless a calibration has been opened first.

When trying out new calibration settings from the MONITOR ENGINE screen, the changes can only be made permanent with a new download after the desired changes were made in the EDIT CALIBRATION menu. A quick way to make permanent changes is to switch back to the EDIT page by selecting E from the MONITOR screen, then making the changes, and if the REV LIMITER is set to COIL CUTOFF, you can re-enter the MONITOR screen by typing M and select K for kill engine, which will shut off the engine and bring you back to the EDIT screen, at which time you can select "Ctrl" and "Z" which will save your changes, overwrite the calibration with the new values and download the new calibration into the TEC.

COM ERROR

This message is displayed when communications are not established, check that the appropriate COM port is selected, check all wiring, and verify that you are running compatible software on your computer and the TEC.

Here is a list of possible Solutions to a persistent COM ERROR:

Check to make sure that the TEC-II or HPV-3b is powered by at least 10 V on Power Side Pin #9 (SW BAT).

Some PC's will not communicate with the TEC properly if you are running inside a DOS shell of another operating system such as Windows, try shutting down your computer and restarting in DOS.

Make sure that the COM cable is shielded without interruption from the TEC to the PC. Your alternator may be making too much noise, you may want to check by taking the belt off of the alternator.

The PC or Laptop that you are using may be too old to support TEC communications a +12V/-12V com port will not work.

Check your sensor wiring, if a 5 V reference terminal is shorted to ground the TEC will not power up. A good check for this condition is your check engine light, if your TEC does not make it come on when you turn the key into the ON position, your micro-processor is not being powered up or your 5 V reference is shorted to ground. Try disconnecting each sensor one at a time at the TEC until your check engine light comes on with the key (it will go out when it sees a cranking signal).

Several calibration values must be set before the engine is started. Arbitrary values have been entered into the recommended starting calibration, but every engine will vary.

No symbols should appear under the **FAILED** column in this screen. If one appears check both the Hardware and Software sections for information on that sensor.

BEFORE YOU START THE ENGINE

Before the Engine is started, the following terms and procedures must be understood. After these basic fundamentals have been taken into consideration, the engine can be started, and the tuning can begin.

1. Firing Scheme

Before calibration can begin, a firing scheme for the injectors must be selected. Electromotive has provided the Total Engine Control systems with the ability to fire the injectors in two basic formats: Simultaneous - this scheme fires all injectors at the same time. Alternating - this fires the injector drivers one at a time. When using multi-point or port fuel injection, or any configuration in which it would be beneficial to time the injection events with the individual cylinders, an alternating scheme will be the best choice.

2. Number to divide TACH by

First we need to understand TACH EVENTS. A four cylinder fires a coil (has a TACH EVENT) every 180 degrees, or twice per revolution. A six or twelve cylinder TEC has a TACH EVENT every 120 degrees, or three per revolution. An eight cylinder TEC has a TACH EVENT every 90 degrees, or four per revolution.

Next we need to understand that an ALTERNATE firing scheme triggers the injector drivers one at a time in alternating events, this means that on a four cylinder Inj 1 (A) fires first, then Inj 3 (B), a six cylinder fires Inj1 (A) first, followed by Inj 3 (B) and then Inj 2 (C). Eight cylinder units with Quad proms (Phased Sequential Units) first fire Inj A, then Inj C, then Inj B followed by Inj D. Eight cylinder units without Quad proms (Special Ordered Batch Fire Units for Throttle Body Injection) fire Inj A and Inj B together first, and then Inj C and Inj D together.

When a SIMULTANEOUS firing scheme is selected, all injectors drivers and injectors fire together at the same time.

The NUMBER TO DIVIDE TACH BY is when the injectors fire, a one means that every time a coil fires an injector event is triggered, when a two is selected the next injector event skips a coil firing first.

3. Time on for one GAMA (TOG)

This is the foundation of the Electromotive Total Engine Control philosophy. The TEC fuel calculation is $(MAP \% \times TOG \times GAMA) + IOT$. What this represents is really quite simple, if an engine can fill the cylinder with a known volume of air at 100 kPa (standard atmospheric pressure)

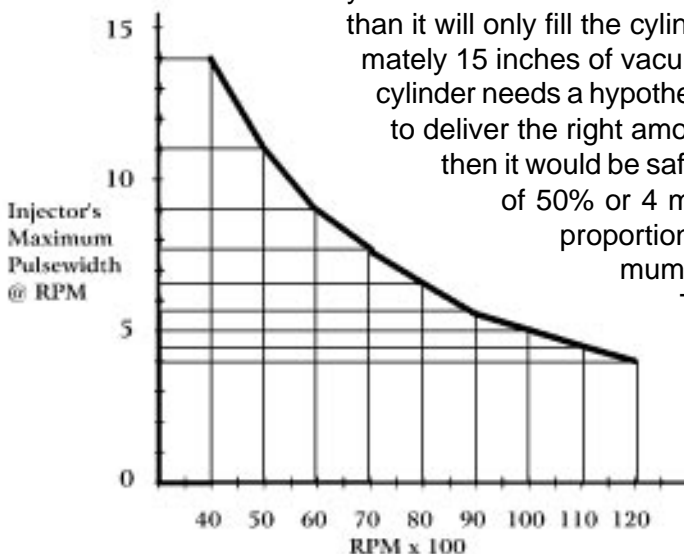

than it will only fill the cylinder with 1/2 that amount of air at 50 kPa (approximately 15 inches of vacuum). Assuming this is a fact and we know that the cylinder needs a hypothetical 8 millisecond injector pulsewidth at every TDC to deliver the right amount of fuel at 100 kPa manifold absolute pressure, then it would be safe to say that at 50 kPa you would only need a factor of 50% or 4 milliseconds to keep the fuel mixture at the proper proportion. TOG is the value for one cylinder filling at maximum engine RPM and 100% of MAP or MAF. The actual

TOG that will be used may not allow the injector pulsewidth to exceed the amount of time between injector firing with one milli second of recovery time subtracted, unless it is intended to make the injector hang open.

A. Selecting a starting TOG (Time on for one GAMA)

In order to select a starting TOG, steps one and two above must have been completed. First determine the maximum amount of Time between injector firing events. Determine the maximum RPM to be used, then, dividing 60,000 milliseconds (one minute) by said maximum RPM will yield the time between Top Dead Centers in milliseconds. Dividing the time between TDC number by how often this injector fires per revolution, (if you use an alternate, divide by 2, the injector fires once every other TDC, so you will have to divide by 0.5) will give you the time between injector firing.

Example: 60,000 divided by 7,500 RPM = 8 milliseconds

In order to maintain proper fuel control at this RPM, the injector needs a little over one millisecond (ms) recovery time between firing events, so 1 ms must be subtracted to obtain maximum TOG.

Example: 8 milliseconds minus 1 millisecond recovery time = 7 milliseconds.

B. Adjustments to TOG

One of the adjustments that needs to be considered is a compensation to TOG on turbo or super-charged engines designed to run less than the MAP sensor's range. The TEC does not recognize a difference between the signal from a one, two or three bar MAP sensor, so if for example a two bar MAP sensor is used, which has a 15 psi boost range, and the engine is set up to use only 8 psi of boost, then the Time on for one GAMA (TOG) can be set to reflect this. The Fuel Equation used by the TEC is **MAP % x TOG x GAMA (usually 1) + IOT**, so if only 8 out of 15 psi or 22.7 out of 29.7 psi ABSOLUTE are used, the calculated TOG can be adjusted by realizing that the MAP % never exceeds 76.43 % (22.7/29.7 or 0.7643). Now if we know that the max MAP % is 76.43, it will allow the TEC to achieve maximum pulsewidth, although a less than maximum boost level is used.

4. Injector Offset Time (IOT)

Also referred to as IOT, this value is used to change the slope of the raw fuel curve, allowing the TEC to more closely follow the fuel requirements of the engine. You will find IOT in the basic fuel calculation performed by the TEC $(MAP \times TOG \times GAMA) + IOT$, examining the effect it has on the injectors pulsewidth makes clear it's value in tuning. If the engine idle is at 30% of MAP, TOG is at 7.000 ms and IOT is at 0.000 ms, the pulsewidth at idle will be 2.100 milliseconds. Should the IOT be changed to -0.125 the injector pulsewidth at idle will be 1.975 milliseconds, however, the pulsewidth at full load (100% MAP) will now be 6.875 milliseconds. You will be able to increase TOG, or you may have to decrease TOG by the full amount

of IOT in order to keep your wide open throttle value in line with the engines demand. In the last example, TOG could have been increased by 0.125 to reflect the -0.125 IOT and the injector pulsewidth would look like this: TOG = 7.125 and IOT = -0.125 at 100% load the injector pulsewidth would be 7.0 milliseconds and at 30% load the pulsewidth would be 2.0125 milliseconds. A more extreme example: TOG = 12.0 and IOT = -5.0 now at 100% load the injector pulsewidth would still be 7.0 milliseconds, however, at 30% load the injector pulsewidth would be -1.4 milliseconds and not fire at all, in fact the injectors would probably not fire until somewhere over 50% load. The IOT is used primarily to establish proper idle pulsewidth values.

5. Minimum Turn-On Time for Injectors

This value is used when a injector is required to operate close to it's minimum delivery during idle. Should there be some difficulty in getting the engine to idle properly due to the size of the injectors, this value can help in smoothing the engine out. A fuel injector needs a certain amount of energy to function at all, this translates to pulsewidth values between 0.9 and 1.3 milliseconds for most peak and hold type injectors. When the injector is pulsed for less than the amount of time required to move its pintle off of its seat, the injector will not spray any fuel, for example: the injector begins to spray some fuel at 1.31 ms but delivers no fuel at 1.28 ms, then in order to keep the TEC from trying to adjust the fuel to 1.28 ms and stalling the engine, the Minimum Turn-On Time for Injectors needs to be brought to somewhere above 1.28 ms. This will allow the engine to run as lean as possible without stalling out. Should idle pulsewidth values be significantly higher than 1.3 ms (somewhere between 1.3 and 1.8 ms for Saturated Injectors), then a Minimum Turn-On Time will usually not be necessary.

6. MAP OFFSET and AUTO MAP CAL (NOTE: DO NOT USE THIS FEATURE)

MAP OFFSET lets you manually offset your calibration tables for extreme changes in altitude by entering the difference in kPa between where the engine was tuned and where it is running. With today's MAP (Manifold ABSOLUTE Pressure) sensors, however it is better NOT to use this feature, for the TEC automatically adjusts the fuel based on the ABSOLUTE pressure generated by the MAP.

The AUTO MAP CAL found in PAFZ systems does pretty much the same thing that the MAP OFFSET does, however it makes a kPa comparison at every 'key on' and automatically enters in the offset required. As in MAP OFFSET, it is recommended that you DO NOT USE THESE FEATURES, because today's MAP sensors, for all intents and purposes, have this built into them.

7. Ignition Advance

The advance table defines the RPM and load breakpoints that will be used for Spark Advance, as well as the Volumetric Efficiency and General Purpose Output tables. These values will define the 64 spark advance points used in the TEC's ignition system. The TEC linearizes in a straight line between these points. Two other parameters are set here: the range of the MAP sensor and the Initial Advance.

Setting up the advance table will be at least a two step process. Initially, conservative values should be entered which will allow the fuel curve to be fine tuned with minimum risk to the engine. With fuel dialed in, then the optimum advance numbers can be determined using the Engine Monitor Screen and key '3'.

Begin by determining the mechanical timing offset. Start the engine and run it at idle. Go to the Engine Monitor screen and hit key '1'. This forces the electronic advance to zero. Using a timing light, look at the timing of cylinder number one. WARNING: if you are using a "dial back" light you must divide the reading in half to get the real timing angle or set the dial to zero and use only degree marks on the crankshaft. It is not necessary to have the mechanical advance at exactly zero, but it will simplify electronic timing. Reset the mechanical advance to zero by moving the distributor pickup assembly or sensor bracket. Once the mechanical timing is known or set to zero, turn the engine off and go to the Edit menu. Use the cursor keys to go down to "Change Advance table."

Note on Using 2 or 3 Bar MAP sensors

It is possible to correct your screen readings for use with a 2 or 3 bar MAP sensor as used on forced induction engines. First, find what range manifold pressure sensor you have (1, 2 or 3 Bar). Move the cursor down to the MAP BAR # and set it for the MAP sensor you are using. Now the MAP range will go up to 200 kPa for a 2 bar boost sensor and to 300 kPa for a 3 bar boost sensor. The Engine Monitor Screen will also read correctly.

G.M. MAP Sensor

Naturally Aspirated Engines	039 XXXX	(these are casting #'s
Forced Induction Engines under 15psi boost	886 XXXX	found on the back side
Forced Induction Engines under 30psi boost	749 XXXX	of the connector area)

Initial Advance

Set the initial advance for the desired advance angle between 400 RPM and the first column's RPM. The mechanical advance, if present, must be subtracted from the desired advance before it is typed in. If the mechanical advance is zero then the computer display is the actual timing value. Note that as soon as the engine RPM drops below 400 RPM, the advance angle will drop immediately to zero. It is important to set the initial advance so radical changes in advance angles will not cause the engine to stall. The initial advance works from 400 RPM to just below the first RPM point in your table. It again is important to set the numbers in the first advance table column near the initial advance so that radical changes in advance angle won't upset the engine.

Table Breakpoints

Move the cursor around the Advance table to change any of the MAP or RPM break points. The selection of the break points should match the meaningful operating range of the engine. If you are tuning a slow revving tow vehicle engine, the highest RPM might be around 4500 RPM. If the engine is a race motor that does not produce power till over 6000 RPM, the first column might be set at 1500 RPM to allow a smooth transition from idle, and the 2nd through 8th columns could tune for 6000 to 10000 RPM. The same holds true for the MAP breakpoints. If a street camshaft is used, the first MAP should be around 30 kPa, the last around 100. If a highly overlapped, radical camshaft is used, the first MAP might be up to 50 kPa, the last at 100.

Once the appropriate MAP and RPM breaks are found, type in a rough Advance curve to get up and running. The first columns on the left should be low numbers with even lower numbers toward the top of the screen. The top row is the row that defines the Wide Open Throttle, full power condition of the engine. These advance angles should be set low to prevent detonation. The bottom right region represents light load, coasting where higher advance numbers could be used. Remember that the mechanical advance, if your timing wheel is not on exactly the trailing edge of the 11th tooth, must be factored in before the table entry is made. The accuracy of the Advance curve is not critical now since you will be finding the exact advance angle later. However, it is important that no holes or spikes occur in your table and the table is generally smooth and without large differences in advance between adjacent cells.

Typical Advance Curve

The above curve is for when the manifold pressure (MAP) is equal to 55 kPa. There are 7 other curves that the TEC uses for the 7 other MAP break points. The TEC also linearizes between adjacent curves if the MAP or RPM does not fall exactly on the break point.

Start with the Advance Table in the included sample calibration. Due to the faster burn of the TEC ignition, advance is often one or two degrees below what was previously used. Once a start-up advance curve is in, hit "X" to exit and save and download to your TEC.

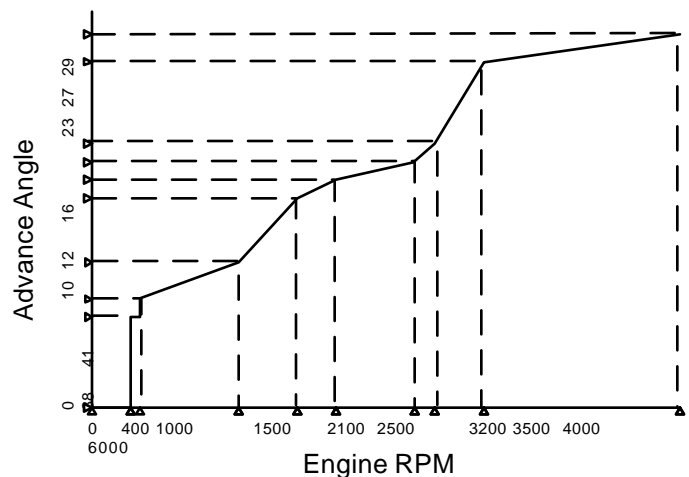

Advance Curve for MAP = 55 KPA



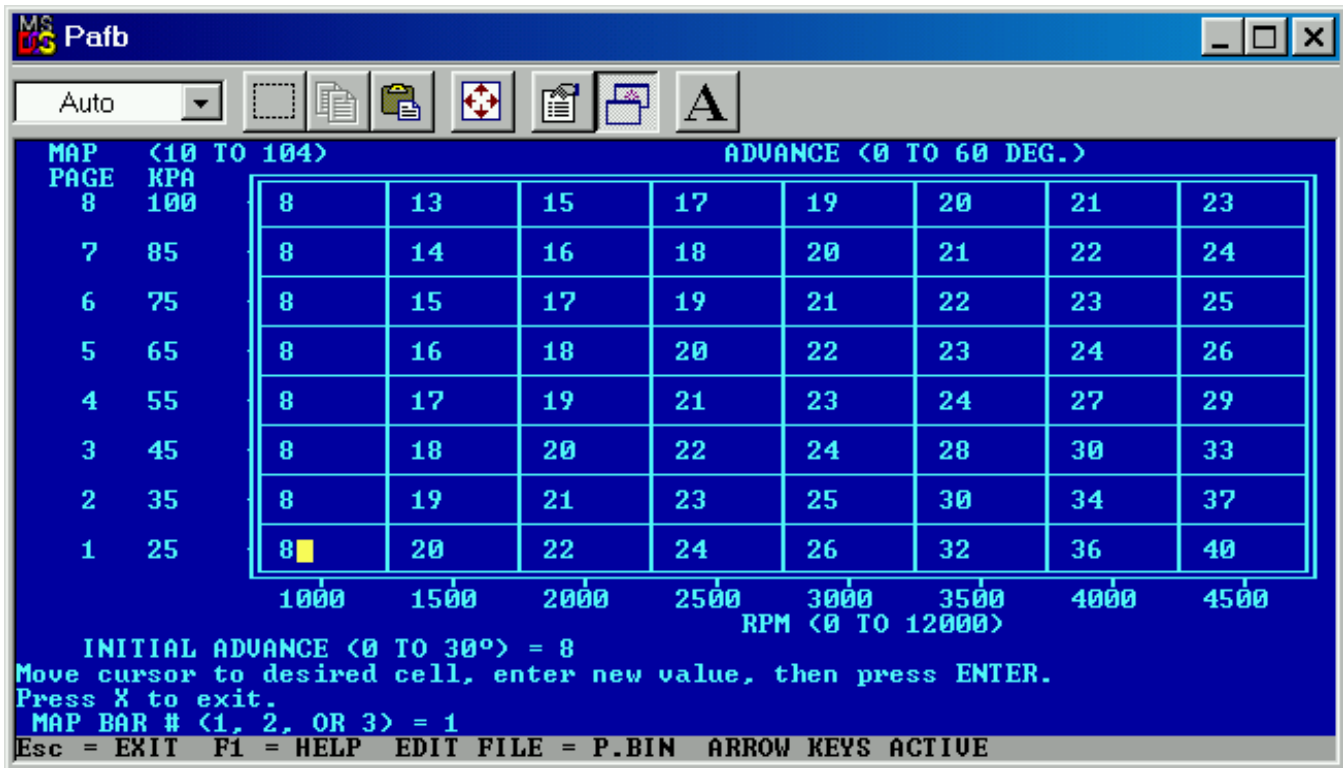

Ignition Advance Table

NOTE: TOO LITTLE OR TOO MUCH IGNITION ADVANCE CAN DAMAGE YOUR ENGINE. USE CAUTION WHEN SETTING YOUR ADVANCE CURVE.

Once the fuel curve is determined, optimum ignition timing can be determined. Start the engine and let it warm up. Run the engine up to an RPM that is a breakpoint and note the MAP. With the engine under load, use key 3 in the Engine Monitor screen to increase or decrease the timing. Find the best timing by holding a steady RPM and load while increasing timing (key 3) until you hear a slight detonation. Back that advance angle down one degree and write down the RPM, MAP and Advance Angle. Repeat this for as many RPM and MAP combinations as you can. An alternate method to listening for the knock limit is to tune for peak torque. This is done on a dynamometer by trial and error to find the best advance which produces the highest torque for that RPM and MAP combination. Other methods include lowest NOx point or optimum EGT.

When as many of the 64 cells are done, transfer your data permanently to the Advance Table by going into the Edit Menu and selecting Advance Table. Move around the advance table with the arrow key and type over the old advance angle values with your new ones. If you could not test all the RPM and MAP break points, split the difference between two of the nearest points so that a smooth line is made. Extrapolating in a straight line is OK for points beyond tested RPM and MAP break points. Escape out of the Advance Table and save and download your new calibration.

8. Blend

One of the most innovative features of the various TEC calibration softwares are the Blend parameters available to the tuner with the Super*Blend and Paf*Blend calibration software packages. The purpose of

this feature is to generate the type of MAP signal required to make the TEC's linear fuel delivery function with racing engines that have individual throttle injection systems and/or cam shafts that produce less than 15"Hg at lower RPMs due to a generous portion of Valve Overlap.

Since the primary load input for the fuel calculation is MAP and this is displayed in kPa, you will notice that these racing type engines only produce idle values around 55 to 75 kPa and rather erratically at that. Once the engine RPM comes up '**on the cam**' this isn't a problem any more and a reliable and stable MAP signal is available.

Use the Blend parameters to substitute the MAP signal with a % of the TPS signal + the TPS offset voltage. Usually a 1 bar MAP sensor generates around 1.3V at 36 kPa and if your TPS signal is used as an offset to the MAP, you might want to use enough offset voltage to get the closed throttle TPS voltage + TPS offset voltage to 1.3. Start with about 50% blend from 200 RPM below the desired idle speed all the way to where the engine comes 'on the cam' somewhere between 3000 and 6000 RPM at this point and above use 0%. When you start the engine and it has warmed to operating temperature observe the kPa values and the mixture, should the kPa still be fluctuating by more than 6 kPa, increase the Blend %, should the engine be running too rich, decrease the TPS blend offset voltage and visa versa.

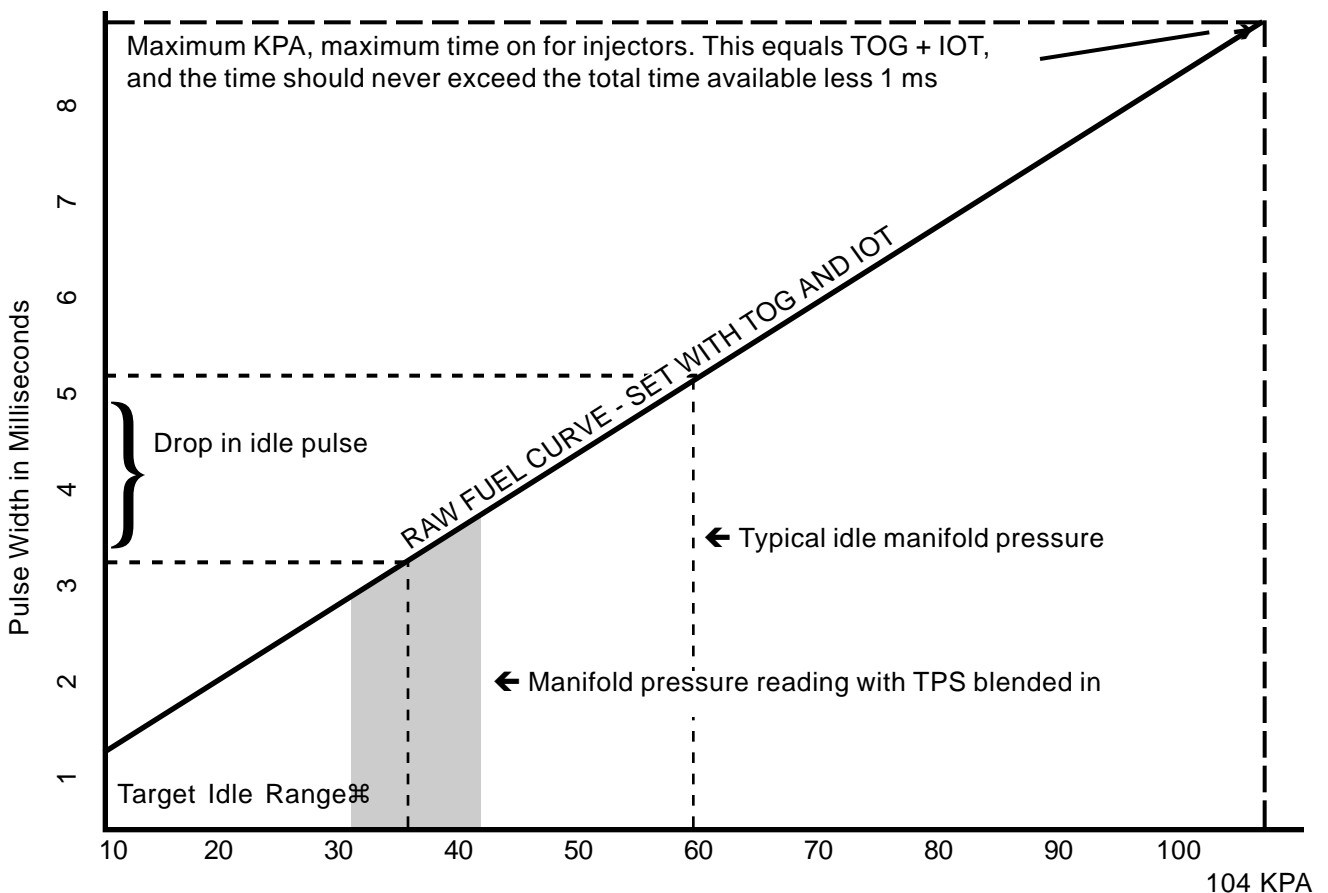

Getting Started and other Tuning Tips

Now that a basic understanding of the primary adjustments is established, it should be possible to start the engine. Use TOG, IOT and GAMA OFFSET to get the engine started, and warmed to operating temperature, then follow the next outline for making the engine drivable.

1. Observe the idle mixture

Using IOT and TOG, get the engine to settle into an acceptable range. You may also need to experiment with the timing by adding or subtracting a couple of degrees. It may also be necessary to readjust the throttle stop so as to have an adequate amount of air flowing. If you are using a MAP sensor try to get the engine to idle with the lowest kpa value possible, this also depends a great deal on cam overlap, so it may not be as low as anticipated. Once an acceptable idle has been achieved by making TOG, IOT and timing changes, record the closed throttle voltage, the injector pulsewidth and the idle kpa as well as TOG and IOT needed to do this. Next review the values recorded and verify that they conform to the parameters discussed earlier. Now change the name of your *.bin file in the edit page of your software and make the changes required for best idle. NOTE: Remember to save the file changes and download the new file to the TEC.

TIP: While in the Monitor Screen, you can turn off the EGO sensor adjustment by typing 'C', this allows you to make adjustments to IOT and TOG without having the Oxygen Sensor feedback interfere.

2. Adjust the idle parameters to achieve a smooth idle

At this point the EGO control should be turned OFF, this will allow the idle to be adjusted without the EGO circuit trying to adjust the mixture at the same time. After a smooth idle has been achieved, turn the EGO control back on to help with the mid range tuning. The EGO parameters may need to be adjusted to help stabilize the idle after it has been turned back on.

IDLE SPEED CONTROL

Idle speed control. ON/OFF <<

SPEED vs. TEMPERATURE TABLE

IDLE SPEED	1300	1000	850	RPM	<500 to 2000>
CLT. TEMP.	-10	30	70	° C	

Number of steps to reset I.S.M. at power on <10 to 255> = 77
Manifold pressure below which to disable I.S.M. < 10 to 104 KPA> = 30

COARSE IDLE SPEED CONTROL

RPM's off target at which to switch to coarse <46 to 300> = 80
Number of steps to decrease speed per wait period <1 to 25> = 4
Decreasing speed wait period <4 to 500 MS> = 400
Number of steps to increase speed per wait period <1 to 25> = 4
Increasing speed wait period <4 to 500 MS> = 400

FINE IDLE SPEED CONTROL

Number of steps per wait period <0 to 25> = 1

SPARK ADVANCE IDLE SPEED CONTROL

Retard timing rate if RPM is too high <0 to 10°/50 RPM> = 0
Advance timing rate if RPM is too low <0 to 10°/50 RPM> = 0

Esc = EXIT F1 = HELP EDIT FILE = P.BIN ARROW KEYS ACTIVE

Idle Speed Control Menu

3. Setting the throttle plates

One of the most overlooked areas in tuning a stable idle is the base throttle plate settings, or minimum air rate. The function of the idle air control (IAC) motor is to compensate for cold start and other loads such as the A/C kicking in and out, or the transmission being put into and out of gear. The idle air control motor is not, however, supposed to be maintaining the base idle speed when hot. When the engine is fully warmed up and not under any load the idle should be about 25 to 50 RPM above the desired hot idle speed, assuring that the IAC is inactive.

In order to adjust these idle speed settings follow this outline:

1. Fully warm up the engine.
2. Disable the Idle Air Control motor and block the bypass-air passages.
3. Set the idle to approximately 25 RPM above the desired idle speed as outlined in the calibration.
4. Re-enable the IAC and verify that the engine RPM is still where you set it.

4. Preliminary acceleration enrichments

Adjust the acceleration enrichments and try them out by snapping the throttle in neutral to make sure the car will be drivable. Adjust your deceleration values so they will work adequately enough to get some testing done. Don't spend too much time on this, you will need to readjust these values once the wide open and mid range fuel delivery has been mapped out. Normally aspirated cars should not use any MAP rate of change enrichments, these are only used by forced induction i.e. super & turbo charged engines. The most important adjustments are the sensitivity, the duration of enrichments, the variable amount and the fixed amount of enrichment (ACE0, ACE1, ACE4, ACE5, ACE6 and ACE7 respectively), all other enrichments are best left at zero or turned off until later in the tuning. Enrichments are usually in GAMA values and a 1.2 GAMA value represents a 120% additional injector pulsewidth increase. Keep the values to a minimum, otherwise the enrichments may obscure the raw fuel curve, which has yet to be established. REMEMBER THAT THE 'F1' KEY IN THE PROGRAM WILL SHOW YOU MORE INFORMATION ON THE INDIVIDUAL ADJUSTMENTS.

5. Load Test the engine and verify adequate fuel delivery

If equipped with data-logging software, it will be possible to log some light acceleration or load conditions to verify adequate fueling. If data logging is not available, a little creativity will be necessary, ***it is not recommended to monitor the engine functions with a lap top while driving the vehicle.*** If tests are being made in a driving condition, someone other than the driver should be making the adjustments. Should the engine be too rich under load at the upper end of the RPM range, verify that the acceleration enrichments have timed out and decrease TOG to make the engine lean out. Should the engine be too lean under the same conditions, increase TOG only if the 'before you start the engine' calculations show that an increase in pulsewidth is still possible, otherwise you will need to increase fuel pressure or injector size(s).

6. Set your VE's

The Volumetric Efficiency Table allows for correcting fuel flow in the mid range. TOG should only be used to correct the fuel flow at the RPM limit, the VE table will allow an increase in pulsewidth at RPM's below the limit, for example if the engine is lean at 5,200 RPM, but it is rich at the RPM limit of 7,200, then it is recommended that the TOG be lowered and adjusted for 7,200 RPM and an increase in pulsewidth be effected by entering a positive value in the VE table at that specific load and RPM. Each specific engine RPM has its own pulsewidth limit, so it is important not to exceed that limit. For example doing the math for 7,200 RPM determines the maximum pulsewidth is 7.333 milliseconds and if this is TOG, and the engine is lean at 6,000 RPM where the maximum pulsewidth is 9.000 ms, then the maximum value that can be added to the VE table at 6,000 RPM is 0.227.



7. More (or less) Enrichments

Now that the Volumetric Efficiency Table has been filled out, the Enrichments need to be readdressed. Adjust the Acceleration Enrichments and focus on deceleration. This will allow the fuel delivery to be turned off when certain criteria exist:

- a: the engine RPM is above DCCL0 (cold) or DCCL1 (hot)
- b: the throttle voltage has been decreasing (closing) at a rate of DCCL2
- c: intake manifold pressure or air flow is less than that of DCCL3

Only if all of these conditions are met, will the fuel be shut off. Once one or more of the criteria for shutting off the fuel delivery cease to be met, the TEC will turn the injectors back on. When the injectors are turned back on, it will be necessary to add just a little extra fuel, to wet down the intake air tract and keep the engine from stalling, this is done by DCCL4 and is usually about 5% or .05 GAMA for multi-port engines, and the basic rule of thumb is that the further the injector is from the intake valve, the higher this number will be.

8. Cold Start

At this point the engine should operate acceptably warm and the next step should be to adjust the warm up curves and cold start enrichments. This is primarily trial and error, but a chart can be approximated. It is possible to change the temperatures at which GAMA changes occur, and there is some additional temperature based timing in the Coolant Advance Table.

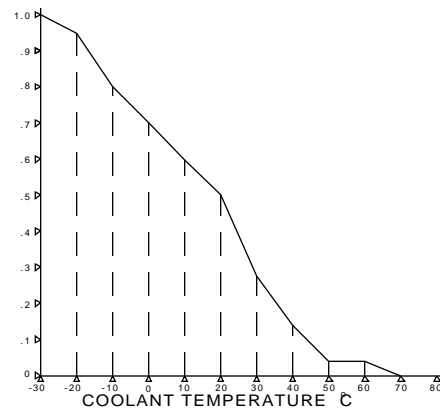

9. EGO Parameters

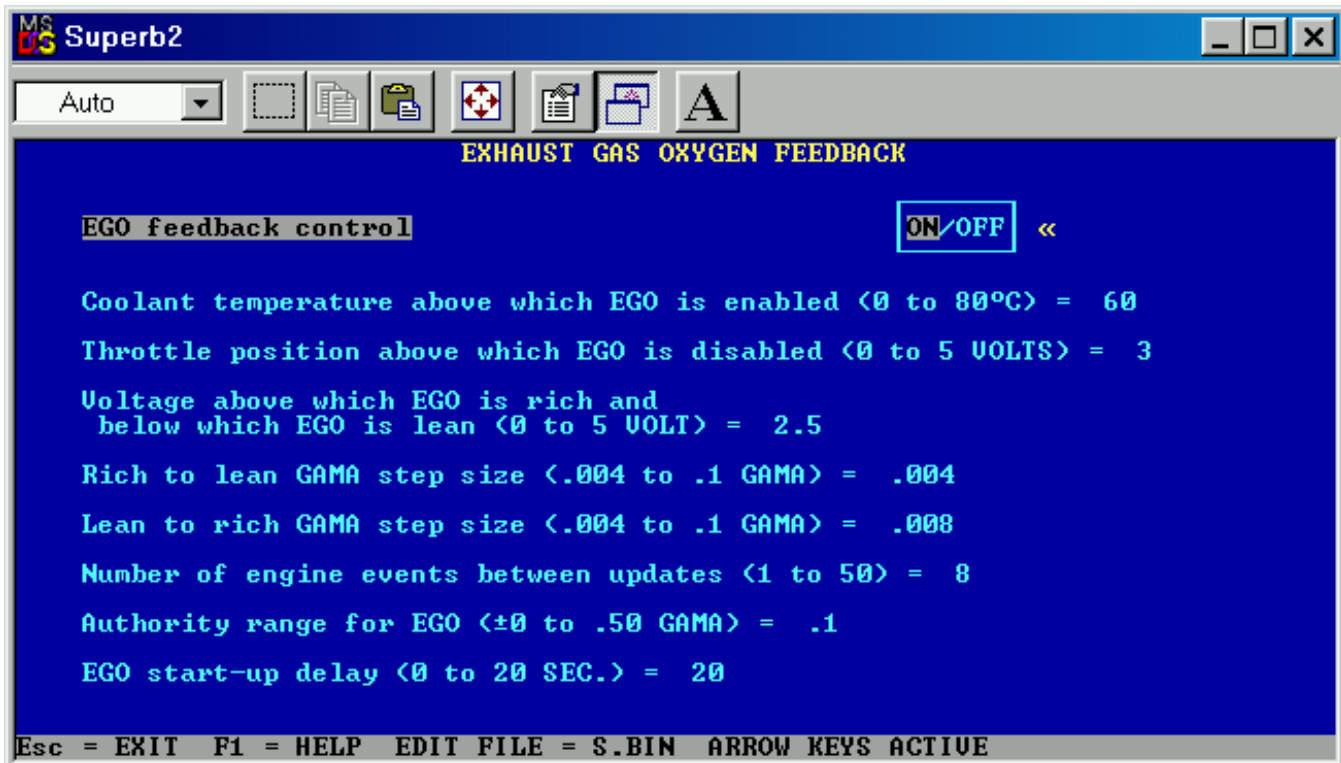

EGO Screen for Super, Super*Blend

The next step is to readjust the EGO parameters to function under the desired conditions, in the right amounts and with just enough authority. Don't rely too heavily on the EGO to make fuel adjustments. The sampling rates, rich to lean step sizes etc. are all located in the EGO parameters. The TEC systems using SUPER & SuperBlend software use one rich to lean switch point in the programming and the Voltages used are raw Oxygen sensor voltages conditioned with a x5 multiplier to operate from 0 to 5 volts (0v = lean and 5v = rich) a 2.5 volt value is approximately 14.64:1 air fuel ratio and a 4.5 volt signal is approximately 12.5:1. PafZ based software uses air to fuel ratios calculated by the TEC and allows a multitude of different target values to be used, making it easy to tune for both performance and economy with the same calibration.

Super Based EGO Parameters

For these software packages the EGO sensor circuit works with the EGO voltage only and the rich to lean break point is chosen by the tuner. Usually a stoichiometric switch point (between 2.25 and 2.5 volts) is selected and then the EGO control is turned off at a certain TPS voltage (usually $\frac{1}{2}$ throttle). In order to run richer mixtures (13.5 through 12.5 : 1) the volumetric efficiency table is used to bring the EGO voltage to approximately 4.25 volts. During the closed loop operation the control circuit makes a lean adjustment in programmed step sizes (rich to lean step size) this value is usually smaller than it's counterpart (lean to rich step size) try 0.008 and 0.012 for starters. The frequency at which the TEC makes adjustments to the mixture is set using the "number of engine events between updates" a higher number will slow down the EGO circuit and produce a more stable idle, too high of a number, however will cause the engine to run at extreme ends of its authority range and should be avoided.

PAF based EGO parameters

AFR error divisor

This adjustment is the step size of the correction to the Air/Fuel Ratio, look at it as a fractional value as in. $\frac{1}{2}$ step, $\frac{1}{4}$ step, $\frac{1}{8}$ step and so on. To stabilize the O_2 fluctuations, increase this number, for example, if it was set to 8, try 16. The larger this number, the smaller the corrections.

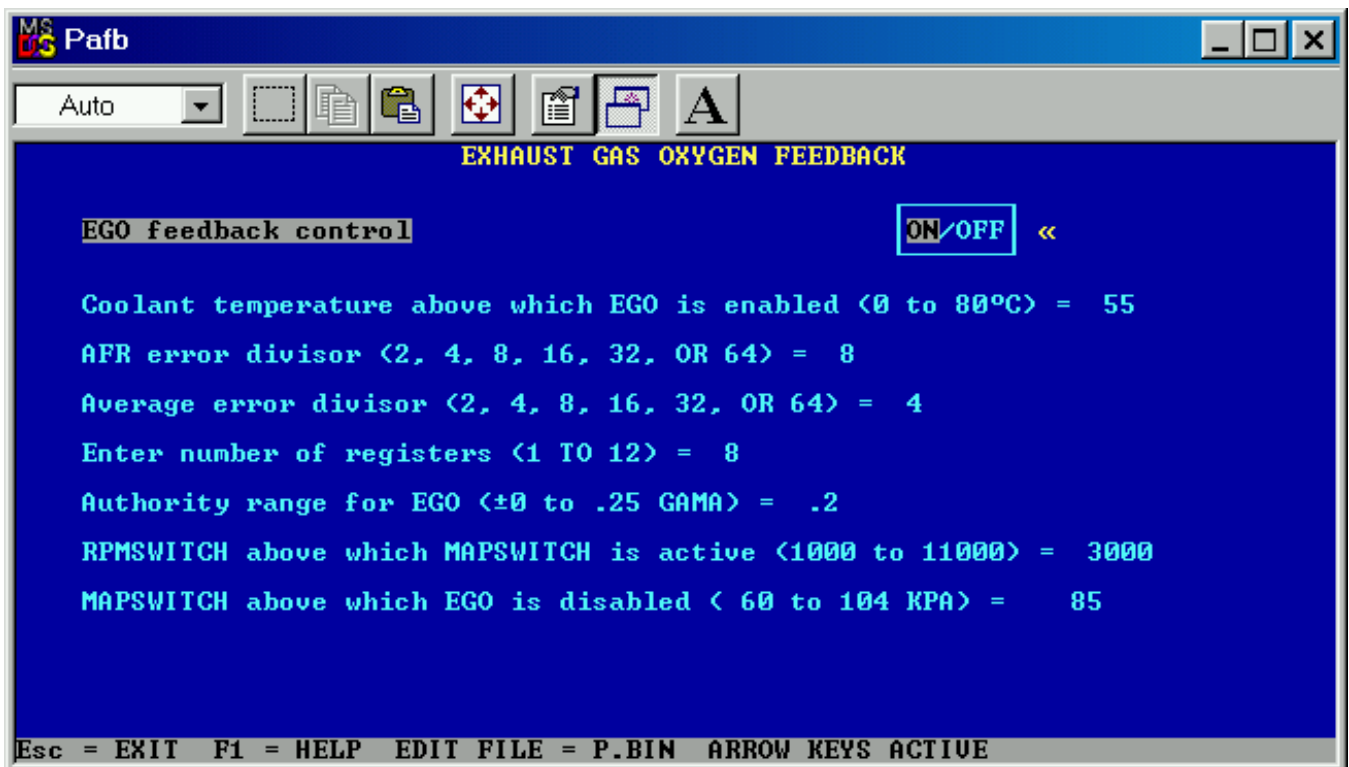

EGO Screen for PAF, PAFZ and Paf*Blend



Average error divisor

The TEC keeps a running average of the last x number of samplings and makes its next adjustment accordingly. Should this number be too large, an overcorrection will occur. Take for example a number of 8, this means that in order for mixture to change direction, you will need at least five rich samplings to make an adjustment leaner. For example five rich readings were taken in a row, and then three lean indicators sampled, though we know that the mixture is now lean, the TEC will lean it out one or two more times.

Enter number of registers

This is the number of tachometer events between updates. Should you be running an 8 cylinder engine and a 4 in this field, the TEC will sample the O₂ sensor every fourth tach event or every 1 revolution (TDC), should this number be 6, then the TEC will sample every 1 1/2 revolutions.

10. Special Considerations for Mass Air Flow Sensor tuning

Should you be using a Mass Air Flow (MAF) Sensor, you need to be aware that the flow capabilities may exceed the air demand of the motor, in which case the MAF will need to be calibrated. In order for the TEC software to work right, your load input - in this case FLOW% - must approach 100%, in order for the TEC to utilize its linear fuel delivery functions properly.

When you initially set up the TEC for MAF, it is usually recommended that you set the PEAK MAF RPM to the torque peak of the engine. After you start to run the engine under load, observe the FLOW% on the monitor screen and make sure it reaches at least 90% while running under load.

If the FLOW% hits 100% the lap top will sound off, it is recommended that at this point you raise the PEAK MAF RPM number in the Raw Fuel and other injector parameter screen.

If you can't find this value, make sure that the calibration file is a MAF file and not a MAP file. You can change this by going to the main menu and typing 'CTRL+A" and returning to the main Change Raw fuel and other injector parameter page to verify that the peak MAF RPM # is now there, make your change (150 RPM higher) and save the changes.

If the FLOW% does not exceed 90% occasionally, you may want to lower the PEAK MAF RPM number in the 'Change Raw fuel and other injector parameters.' screen.

Be sure that all intake air is what is called 'metered' air! This refers to all air entering the intake manifold, such as from the PCV system - in order for Positive Crankcase Ventilation to take place the air must be filtered going into the breather tube of the engine and then directed through the PCV valve into the intake manifold. So in order to measure ALL air going to the engine, the breather must get its air from the intake ducting from between the throttle body and the MAF sensor, the same applies to the Idle Air Control and you must verify that no air leaks in places like the dip stick tube, oil pan gasket, valve cover gasket(s), vacuum break booster etc. exist.

11. Tuning the Knock Sensor

Knock Control is a feedback system designed to reduce engine detonation. It listens for the characteristic sound of knock and automatically retards the spark timing to minimize it. A sensor is bolted on the engine and the signal is monitored by the TEC. When the signal level increases to a threshold point, the TEC begins retarding at a set rate. When the signal intensity drops the TEC returns the timing gradually back to normal.

The primary job in setting up the knock control is setting up the threshold point. Since each engine has a different amount of background noise, each engine should be set up individually.

The first step is to go into the Edit Menu and turn on the Knock control. In the Edit menu go down to "Change Knock control parameters" or enter "K". Use the left arrow key to turn the Knock control on. If the engine is a high speed race engine, it is not recommended to use Knock control at all and the function should simply be turned OFF. To continue, set the selections as noted below.

The knock control threshold must be determined only after the spark timing curve has been com-

pleted. The sensor should be screwed into a central location in the engine. If the knock sensor is not responding, try another engine location. Hook the wire up to the terminal marked "KNK".

NOTE: Detonation can damage an engine. A knock sensor will not catch all detonation, nor is all detonation audible. Do not proceed with the following procedures unless you are completely comfortable with doing so and you know and accept all the risks involved.

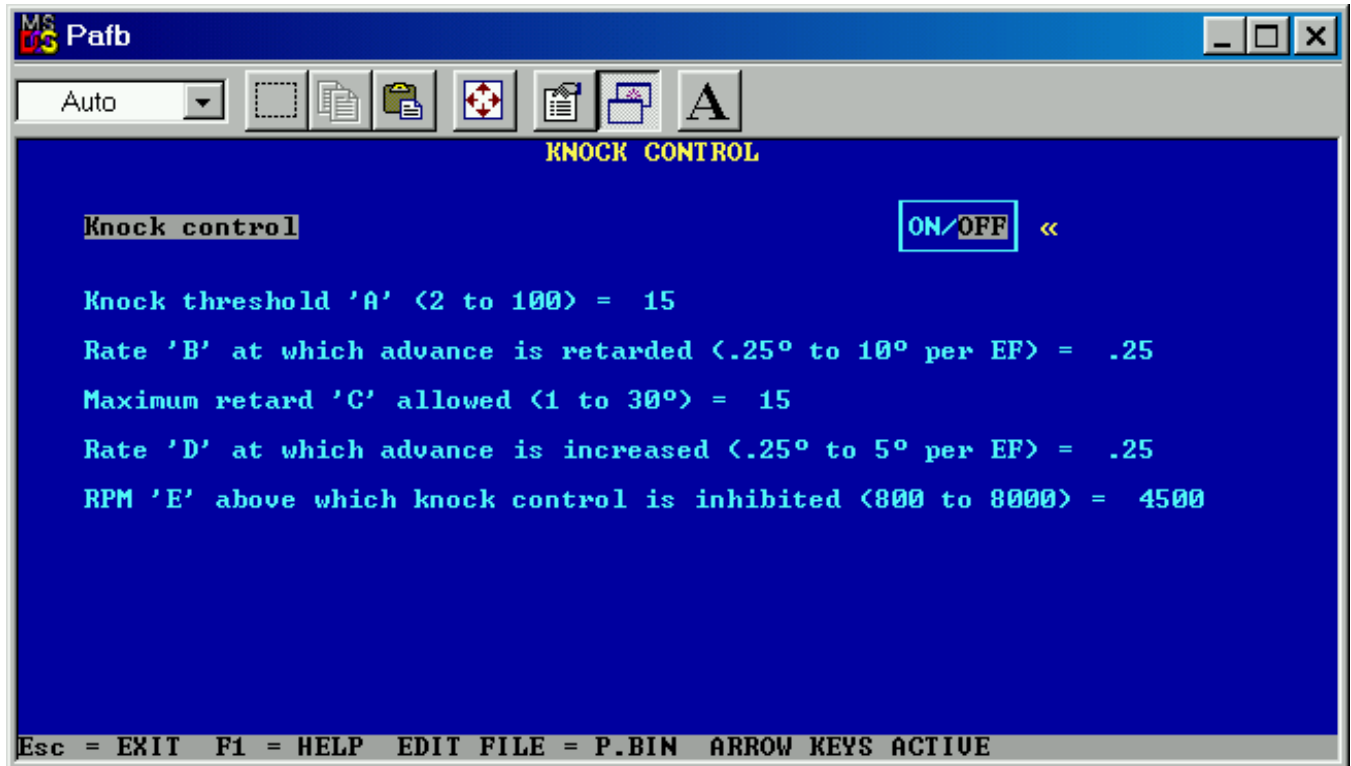

Knock Threshold "A"

With the engine warmed up, observe the Knock reading on the Engine monitor screen. It should be low, below 30. Put the engine in gear and load it by either driving it or running it on a dynamometer. As the engine goes faster the number may go up, even with no knock. With a light load, try increasing the spark timing. Use "key 3" on the engine monitor screen. With a sharp ear you should hear the characteristic sound of detonation with 5 to 10 additional degrees advance. Note that as the detonation comes on the knock number should go up. Using a moderate RPM and load, note the number at which you just begin hearing knock.

Take this number and transfer it into permanent memory by going back into the Edit menu, selecting Change Knock parameters and changing the Knock Threshold to this number. Exit, save and download your new calibration into the TEC. Repeat the same RPM and load and verify that the KNOCK symbol appeared just at the onset of knock. The Knock may be slightly audible but that may be OK. As the knock is occurring, the spark timing should be dropping. If the spark timing drops a great amount and the knock does not subside, then the spark curve is set too high at that RPM - MAP point. Try using key 3 on the engine monitor screen to reduce the timing. Note how far you had to reduce it for the knock to go away. Go back to the edit menu and change the Advance curve. To further assist in making the engine knock, try using the lowest octane gas available or disconnect the EGR valve. Short bursts of power braking against an automatic transmission may also stimulate knock.

Rate at Which Advance is Retarded

When knock is detected the TEC begins retarding the timing once per tach event until the knock



subsides. The rate at which it reduces the timing should be set between $.25^\circ$ and 1.0° per engine function. Setting this too high will cause poor engine response because the engine will be running too retarded at the slightest detection of knock.

Maximum Retard Allowed

The knock control must have a limit to the number of engine degrees that it can pull out. Too much will make the engine run sluggish. Too little will cause excessive knock to come through when you use very low octane gas. Set this value between 10 and 15 degrees.

Rate at Which Advance is Increased

When the engine is recovering from a period of detonation the TEC begins advancing the timing back to what is programmed in the Advance table. This rate should be set slow to keep the engine from oscillating. Set it to only $.25^\circ$ per engine function.

RPM Above Which Knock Control is Inhibited

The Knock function does have difficulty separating engine noise and detonation noise at high RPM's. Therefore, it is necessary to disable the knock function at high RPM's so that the Knock circuit won't pick up stray crankshaft or valve train noises. This is especially true in race cars with solid lifters. Typically, the Knock sensor won't work above 5,000 RPM. This limitation makes knock control for high speed race engines virtually useless. At high RPM, generally, the circuit goes dead and knock could be present without any ability to retard the timing automatically. It is recommended to set the limit to 4,500 RPM and make sure the spark advance curve over 4,500 RPM is not overly aggressive.

12. Rev Limiters

The TEC has TWO Rev Limiters built into the system. Both limit the engine speed in the same fashion, either by cutting off the coils, or by taking the timing to Zero. Taking the timing to Zero only removes the electronic advance, if you have timing built into the trigger assembly to help the engine start, the TEC is not aware of this timing and can not zero this part of the timing out.

The hysteresis of the rev limiter is the # of RPM the engine must drop below the rev limit speed, for the TEC to stop activating rev control.

The first is the overall rev limiter, which is always set to the actual red line of your specific engine. The second, or auxiliary, rev limiter can be used for a number of different tasks.

Using the auxiliary rev limiter as launch control on drag race cars is a common use of this feature.

One way is to have the trans break activate a relay, which in turn shorts the MAT sensor to ground, activating the auxiliary rev limiter. This works best with "ZERO TIMING ADVANCE" mode, where the engine is loaded against the converter. In this adaptation the engine will not make it's full power and it will usually keep the torque converter from being overstressed. Once the trans break is deactivated and the relay stops shorting the MAT, the timing comes back to its normal setting and the engine launches flawlessly. When setting up this function, it is a good idea to set the auxiliary rev limiter about 500 RPM below the stall speed of the torque converter to ensure a smooth operation. This feature also keeps turbo charged cars at near full boost while staging.

Another way to use the aux. rev limiter is to place a switch under the clutch pedal, which shorts the MAT to ground, activating the aux rev limiter. This feature is usually used with the rev limit mode in "COIL CUTOFF". When using this feature, the TEC will kill the ignition abruptly at the RPM limit and wait until the RPM drops by the hysteresis number before turning the coils back on. The nice thing about this feature is that while the coils are turned off, so is the fuel, which keeps the plugs from being fouled, and the mufflers from being blown off of the car.

Using the aux rev limiter as a VALET MODE or for SPEED CONTROL through the pit area simply require a switch from MAT to ground to be placed in a inconspicuous or conspicuous place in the car to activate the aux. rev limiter and the RPM to be set to the desired amount.

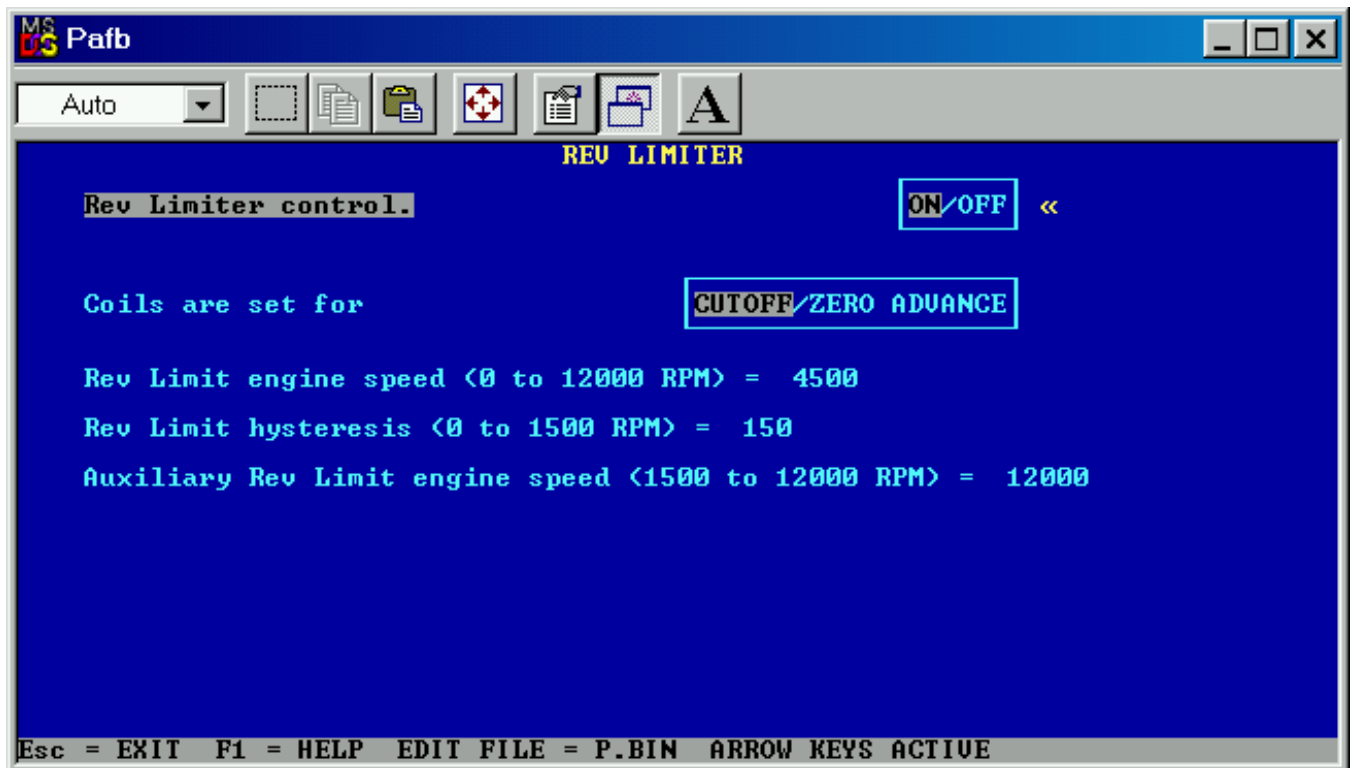

The aux rev limiter can also be used in conjunction with pneumatic and solenoid shifting devices. This requires some trial and error to determine the best solution. One or the other limiting methods may work better for your specific application. Simply hook the shift button to another relay and short the MAT to ground while the button is activated. Make sure to set the aux rev limit low enough to engage while you are shifting.

NOTE: The TEC will only allow for one rev limiting mode for both the main and aux rev limiter, so you need to make sure that if you select 'zero advance' it will also be sufficient for both main and aux rev control. CAUTION: some engines will not stop revving with the timing taken away.

CAUTION: Should you have selected a rev limit of 5,000 rpm, and the MAT sensor shorts out accidentally, the aux rev limiter is engaged and should it be set to anything over 5,000 rpm, then that's where the rev limiter will engage. So don't set the aux rev limiter any higher than the main rev limiter, otherwise you may unintentionally activate a higher than normal rev limiter.



TROUBLESHOOTING GUIDE

The troubleshooting guide is to help you perform basic diagnostics after you have double checked all of the above installation instructions. The following assumes that the engine's mechanical systems are in good working order.

Engine Cranks but Won't Start or Fire

Check: The RPM during cranking by using the engine monitor screen. The RPM should read from 80 to 300 RPM. If RPM is present then the plugs are probably firing. To verify plugs firing, use a clip on inductive timing light on each plug wire to see if it strobos the timing light.

Fix: If the plugs are not firing and no RPM appears, Check and set the magnetic sensor for the correct air gap. Also check the teeth of the pickup wheel and repair or replace if damaged. The run out of the wheel should not exceed .002" TIR.

Check: Open Sensor lead: With an Ohm meter measure the resistance between the Red (A) and Black (B) magnetic sensor lead. It should normally read between 600 to 800 ohms.

Fix: Check for broken or burnt wires. Replace if necessary.

Check: With the ignition switch on go to the engine monitor screen and observe the battery voltage. With the engine off it should read 11.0 to 12.5 Volts. Now crank the engine over. It should read no lower than 9.0 volts. When the engine is running with a an alternator, it should read 13 to 16 volts.

Fix: If the voltage drops below 9.0 Volts during cranking, recheck, replace or clean all wiring and connections. Replace battery if necessary. NOTE: the TEC-I uses a power relay between battery + and the red wire on the TEC as well as the DFU. The TEC-II has a relay built into the power board inside the TEC, therefore the red wire of a TEC-II should go straight to Battery +, however the battery Voltage is monitored on the control board of a TEC-II, which is powered up on the terminal marked SW BAT (pin 9) on the power side connector, check and make sure that the voltage here is not effected by cranking, some cars turn their accessory power off during cranking, and if you use accessory power to activate switched battery, your TEC-II will display "COM ERROR" when cranking, and it will not start.

Check: Gear or other close proximity steel is magnetized.

Fix: Demagnetize or replace parts.

Check: Slow revving starter motor:

Fix: Rebuild or replace starter motor. Replace motor with faster high torque or gear reduction type. Clean all electrical contacts and motor brushes. Use lighter engine oil especially in new engines.

Engine monitor shows RPM and spark is occurring but no start

If the plugs are firing and in the right sequence than the fuel must be insufficient to start the engine.

Check: the clicking of the fuel injectors. This can be done by listening to them or feeling them while cranking.

Fix: +12 volts must be reaching one terminal of the fuel injector. Repair this wiring as necessary.

Check: that the fuel injectors are firing long enough. Go to the engine monitor screen and while cranking the engine increase the IOT (key 6) until sufficient fuel reaches the engine.

Fix: Edit and Save the new calibration with a longer IOT.

Check: That fuel pressure is sufficient and fuel pump turns on.

Fix: Verify proper type of fuel filter and make sure regulator is working, replace parts as necessary.

Engine fires but runs poorly, erratically or dies at high RPM

Check: The sparkplug wires must be all on and in the firing order stated in the Spark Plug Wiring Section. Check for shorts or burnouts through the insulation.

Fix: Adjust the wires to the correct firing order. Replace Wires.

Check: The sparkplug wires must be rated suppression style.

Fix: Replace the plug wires with 8.0mm Packard Radio Suppression stock cables or equivalent.

Check: All ballast resistors must be removed from circuit. Some stock vehicles have resistance wire between the coil B+ and ignition switch. Inadequate +12v supply. Poor ground to engine block.

Fix: Replace wire with 12 GA copper hookup wire. Add ground from the unit to engine block.

Check: Age of battery, damaged battery or poorly charged. Loose lead plates in battery from vibration.

Fix: Replace Battery with a gel cell type battery

Check: The sensor and pickup wheel must be installed accurately according to the installation instructions. Check the mechanical timing at TDC by removing #1 sparkplug and look at piston position. When #1 piston is at TDC the sensor should be aligned with the 11th tooth. Check run out of the wheel. Look for damaged teeth. The sensor bracket must not vibrate at high speeds. Check mechanical timing with a timing light at cranking speed by turning the fuel off. Check the wiring of the magnetic sensor connectors. All three wires colors should not cross circuit.

Fix: Realign sensor and wheel according to installation procedures. Replace sensor or wheel

Check: The calibration must be set according to the instruction manual,. A poor calibration could cause low power. Do not use a "Dial Back" timing light since the double firings will give false readings. Use a standard timing light or a dial-back light set at "0 degrees" and look at markings on the crankshaft.

Fix: Study how to calibrate the unit and improve the setpoints.

Note: When using a timing light only one of the plug wires attached to any coil goes positive, the other goes negative. If the timing light won't fire correctly or produces extra jitter change the pickup over to the other wire on that given coil. The Timing Mark should vary with amount of timing but should be stable, If Not...

Check: The screws holding the coils to the baseplate. They must be tight and grounding the coil inner steel.

Fix: Tighten screws, replace star washers, clean corrosion.

Check: Fuel mixture too lean at power runs. Fix: Increase TOG by 10% at a time.

Check: Advance timing too great. Fix: reduce timing curve for 31° maximum at WOT.

Check: Injectors too small producing fuel starvation at high speed. Fix: Increase injector flow rate.

Engine runs but has poor idle quality or oscillates at idle

Check: Injectors are too large. Fuel injector pulse width insufficient to hold injector open for adequate spark pattern.

Fix: Increase "divide by" number to fire injectors less often but with more pulse width. Reduce injector flow rating.

Check: Poor or erratic MAP signal from poor placement of MAP port.

Fix: Move MAP port manifold fitting to a centrally located position.

Check: mixture too lean at idle or low power. Fix: increase IOT

Check: Idle speed control and EGO feed back parameters are too fast thus producing oscillation.

Fix: Try unplugging the ISC motor to isolate the ISC. Slow calibrations down by lengthening update periods and reducing correction amounts.



Engine runs rich at idle and then leans out at light load part throttle

Check: Radical camshaft produces poor volumetric efficiency at closed throttle thus giving higher than normal MAP signal. Consider upgrading your software to a **BlendVersion*.

Check Engine Fault codes:

Note the code number by the number of short flashes.

Number of Flashes: Failure:

- 1 Coolant Temp. Sensor (CLT)
- 2 Manifold Air Temp. Sensor (MAT)
- 3 Manifold Pressure Sensor (MAP)
- 4 Exhaust Gas Oxygen Sensor too Lean (EGO)
- 5 Throttle Position Sensor (TPS)
- 6 Low Battery Voltage (LOB)

Refer to the hardware section on each of the above sensors to check for correct wiring and operation.

CODE 1 CLT The TEC uses an NCT (negative coefficient thermistor) to determine the temperature of the engine. This input is used to control: Fuel mixture, spark timing and idle speed. The TEC-II applies a voltage (approx. 5volts) to terminal 1 (CLT) of the signal inputs connector. When the engine is cold the sensor resistance is high, therefore the TEC will see a high signal voltage. As the engine warms, the sensor resistance becomes less and the signal voltage drops. At normal operating temperature the voltage will measure about 1.5-2.0 volts at the TEC terminal "CLT"

CODE 2 MAT The TEC is equipped with a Manifold Air Temperature sensor circuit in order to correct the fuel mixture for different air density (temperature) conditions. The TEC supplies a voltage (aprox. 5 volts) to the MAT terminal on the signal inputs side. The MAT is a NCT with similar resistance to temperature values as the CLT and functions much the same way. Use the following values as a guide (values are aproximated) :

Temp in °C: 100° = 185 ohms	4° = 7,500 ohms
70° = 450 ohms	-7° = 13,500 ohms
38° = 1,800 ohms	-18° = 25,000 ohms
20° = 3,400 ohms	-40° = 100,700 ohms

CODE 3 MAP The Manifold Absolute Pressure (MAP) sensor responds to changes in manifold pressure / vacuum. The TEC receives this information as signal voltage that will vary from 1.0 - 1.5 volts at idle to 4.0 - 4.5 volts at wide open throttle. If the MAP sensor fails the TEC will substitute a fixed default value as per sensor failure parameters. NOTE 2 and 3 bar MAPs only read 4.0 - 4.5 volts at full boost range of 2 or 3 bar respectively, they also return less voltage at idle. The TEC supplies 5v and ground to the sensor and it returns a modified voltage to the TEC on the MAP terminal.

CODE 4 EGO This code is set if the Exhaust Gas Oxygen sensor shows a lean condition for a time period longer than specified in the sensor failure parameters, Be aware that if the EGO parameters and Raw Fuel parameters are set to lean and the EGO's authority range is not enough to richen the mixture then this code will set. Should a spark plug or plug wire be defective then the mixture in that cylinder will not burn, the oxygen sensor will see the unused oxygen and will indicate a lean condition. Most later applications will use a 4 wire (heated) sensor which requires one 12v (key switched) and one ground at the white wires. The Oxygen sensor is only capable of detecting the presence or lack of oxygen in the exhaust.... it is not capable of detecting raw fuel.

CODE 5 TPS This code sets if the voltage on the Throttle Position Sensor is above of below a value specified in the TEC calibration. The angle of the throttle is measured by a potentiometer which sweeps closer to ground when the throttle is closed and closer to 5volts when the throttle is opened. Remember if the sensor failure parameters are set into the operating range of the sensor it will surely cause this code to set.

CODE 6 LOB Low Battery Voltage is a sign that the TEC is receiving less than 8 volts between the black lead and SW Batt. If you are using the old coil pos lead as your SW BATT signal and it was originally equipped with a resistor to keep the coil voltage down then you may experience this code, in fact this code would be set if your ignition switch was beginning to show its age (building up resistance). Of course an inoperative alternator would do this as well. Check ignition circuit and power / ground connections.

DATA LOGGING

The data logging and display software is optional with PAFZ II or SUPER II, and standard with Super*Blend and PAF*Blend. It contains two more selections on the main menu to allow graphical monitoring and storage of engine operating parameters. The programs can be used in place of the standard versions and the calibrations are compatible with the counterparts. The program names are SUPER2G, SUPERB2, PAFZ2G and PAFB.

To Save a Session on Disk

Hookup the TEC to the PC, the same as for engine monitoring. Get the PC ready to start the recording session by selecting "Data Graphics" from the main menu. The computer will ask you for a file name in which to store the data. Type in a file name up to 8 letters or digits and hit enter.

You must now specify the rate at which to save the data. Select 1, 2 or 3. Speed depends on your computers clock rate and available storage. Since the time is computer and storage medium dependent, it is best to make several test runs at one repetition each. Using the seconds display, you will be able to determine the time and storage space for each repetition.

Now determine how many screen repetitions you want to save. The program will start immediately after typing this number and hitting enter. Once the MAP Bar # is entered, recording is initiated.

Once initiated, data will start streaming across the screen graphically. When the line gets to the right edge the screen will clear and start over again. This will continue until all the repetitions you set are completed. To stop the storing of data hit "ESC" anytime and the trace will end as soon as it finishes the current screen.

Recalling Saved Data

To review old data go to the main menu and select "View an existing data file." The program will ask you for the data file name. Enter the name (no ending needed) and the computer will start retracing graphically just as it did when you first recorded.



Finding Details on the Replays

To extract exact information on each of these traces and the time it occurred at you must use the arrow keys to move a time cursor around the graphs. In each box you will see the actual reading at that exact moment in time. To find the time between two points move the cursor to an important event such as a peak RPM. Write the seconds number down found in the upper right corner. Move the cursor to another event and subtract the new seconds number from the other. The difference is the elapsed time.

Keyboard Commands

left arrow	1 move left
Right arrow	1 move right
Up arrow	10 moves right
Down arrow	11 moves left
Page up	100 moves right
Page down	100 moves left
C or F9	Center
Home	Start of file
End	End of file

To Print Out a Graphics Screen

It is possible to print the data as you see it on the monitor. Using the "Print Screen" key on your keyboard. If this does not work, check your DOS manual under "Graphics."

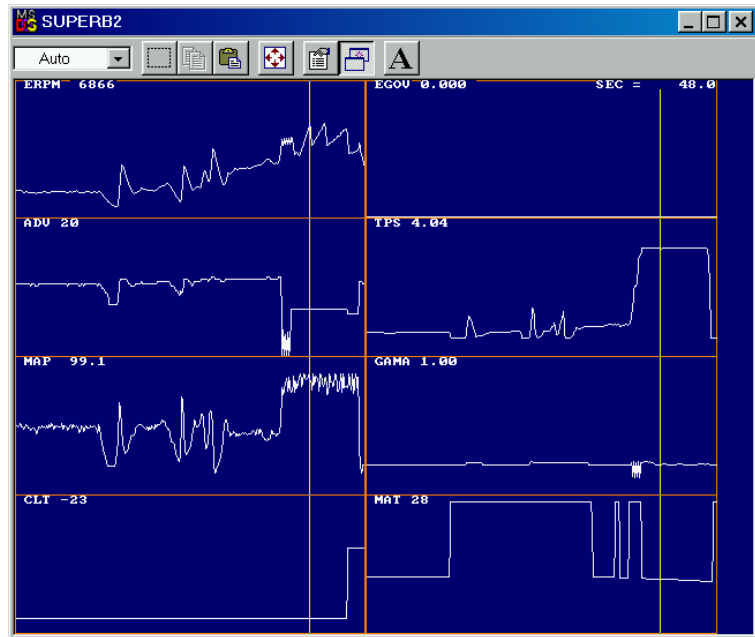

Downloading Data Into Other Spreadsheets

TEC stores the data in ASCII format that can be imported into spreadsheets. You may need to run an import or conversion utility in your spreadsheet to bring it in. The data is set up in columns with the first column being seconds. The columns are arranged as follows:

Column	Data
1	Seconds
2	RPM
3	Advance Angle
4	MAP in kPa
5	Coolant Temp in °C
6	Gama
7	Manifold Air Temp in °C
8	TPS volts
9	EGO volts (raw volts)

These files are large and it may be wise to just import interesting sections to investigate.

Note On PC Hardware

The data logging rates are highly dependent on the speed of your computer and the speed of the disk drives in it. It is best to use a hard disk drive to run the program with a minimum of a 386SX or faster. Slower computers will work but they lack resolution and may not pick up peaks like a faster computer would.

SPECIAL PARTS AND CUSTOM APPLICATIONS FOR TEC'S

In this section you will find some information that is pertinent to nonstandard TEC's only.

Nitrous Oxide Retard Systems

There are a couple of different ways to retard timing in your TEC system when using nitrous oxide.

1. KNK for Single Stage Nitrous systems

(Requires Internal Modification to TEC)

Electromotive has had much success using the Knock Input as a signal to retard the timing on single stage nitrous systems. In order to use this feature the TEC-II must have the KNK input on the circuit board modified either at the time the TEC was ordered or the TEC must be returned for this modification. Once this modification has been performed, the KNK input is terminal #10 on the POWER OUTPUT side of a TEC-II or the faston terminal marked KNK on the TEC-R88 and TEC-1, the TEC will accept a 12 volt signal to activate the knock sensor parameters in your TEC calibration. Run 12 volts from your nitrous switch, which turns on the relay for the solenoids, to the KNK terminal of your TEC. CAUTION! do NOT use the 12V supply for the Solenoids themselves, severe damage to the TEC will result. Set your calibration parameters for the knock control as follows:

1. Turn Knock Control ON
2. Set the Knock Threshold 'A' to 50
3. Set the Rate 'B' at which advance is retarded to its maximum of 10°
4. Set the Max Retard to your desired amount of retard when Nitrous is in use.
5. The Rate 'D' at which advance is increased, should be set to its maximum at 5°.

CAUTION!

The KNK feature is disabled over a certain point, whose highest value is 8,000 RPM. THIS FEATURE **WILL NOT** FUNCTION AT RPM's OVER 8000 !

2. Using the coolant advance table for multiple stage nitrous systems

This approach is recommended only for advanced users of Electromotive's TEC systems and allows you to run, via micro relays, as many as 12 different advance/retard settings over and above the three-dimensional timing curve built into the TEC's advance table. This setup requires you to set the advance table to reflect the least amount of timing that the engine is intended to run under any condition, and then to use the coolant advance table to add in the timing where needed. This will also allow you to add Injector Pulsewidth (GAMA) at different points according to the choke advance tables. In essence, when using this particular setup, the Coolant sensor is replaced with a set of fixed resistance values which are engaged via micro relays. This causes the TEC to see a different Engine Temperature for every stage of nitrous, which allows you to make adjustments to the timing and the fuel amounts based on the coolant advance table and the choke enrichment table.

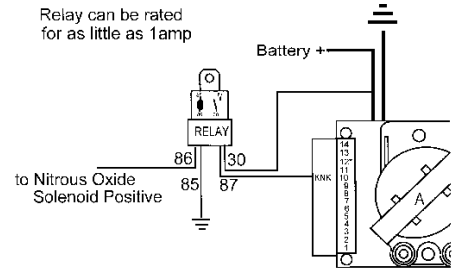

Using KNK Circuit for Nitrous retard